

**Operating  
the  
HP 8565A  
Spectrum Analyzer**

APRIL 1977





# PREFACE

## INTRODUCTION TO SIGNAL ANALYSIS

The spectrum analyzer is an instrument that displays signals in the frequency domain. The CRT on the analyzer displays signal amplitude ( $A$ ) on the vertical axis and frequency ( $f$ ) along the horizontal axis. A method of visualizing how a spectrum analyzer views the frequency domain is to picture a tunable bandpass filter that scans the frequency axis (see Figure 1). At any instant in time, the analyzer will only view the signal it is tuned to receive and reject all the rest. In this way, all the individual components of a signal are viewed separately. In an oscilloscope, the signals are viewed in the time domain and the amplitude displayed represents the vector sum of all signal components.

The purpose of this application note is to acquaint the reader with the HP 8565A Spectrum Analyzer. Rather than diluting the text with extensive coverage of specific topics, the reader is referred to existing application notes on that topic. These application notes are obtainable by contacting your local Hewlett-Packard Sales Office.

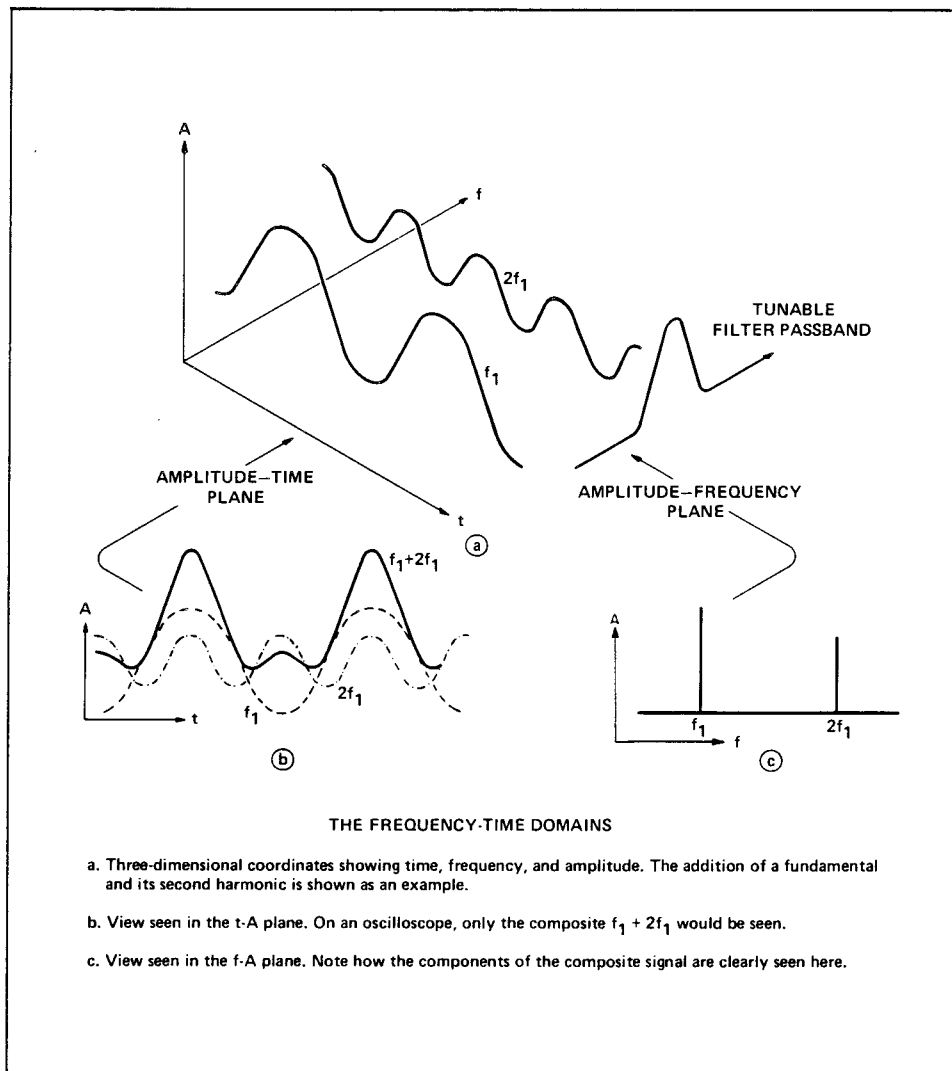

Figure 1. Frequency and time domain

# CONTENTS

BASIC DESCRIPTION . . . . .	1
<b>Chapter 1</b>	
OPERATING THE HP 8565A SPECTRUM ANALYZER . . . . .	2
Normal Settings . . . . .	2
Simplified Signal Analysis . . . . .	2
<b>Chapter 2</b>	
DETAILED CONTROL OPERATION . . . . .	5
Tuning . . . . .	5
Frequency Span Modes . . . . .	5
Resolution Bandwidth . . . . .	7
Reference Level . . . . .	8
Video Filter . . . . .	9
Automatic Sweep Time . . . . .	9
<b>Chapter 3</b>	
SPECIAL TOPICS . . . . .	10
Optimum Dynamic Range . . . . .	10
Improving Measurement Accuracy . . . . .	12
CRT Photography and X-Y Recording Techniques . . . . .	12
External Mixer Operation . . . . .	13
<b>Chapter 4</b>	
TYPICAL MEASUREMENTS . . . . .	15
Distortion . . . . .	15
Modulation . . . . .	16
Noise . . . . .	19
Electromagnetic Interference (EMI) . . . . .	19
APPENDIX: . . . . .	21
A. Operating Precautions . . . . .	21
B. Control Glossary . . . . .	22
C. Front Panel Adjustment Procedure . . . . .	25
D. Theory of Operation . . . . .	26
E. Amplitude Conversions . . . . .	29

# BASIC DESCRIPTION

The HP 8565A is a high-performance spectrum analyzer designed for ease of use. Most measurements can be made with just three controls once the green Normal Settings are preset. The HP 8565A has absolute amplitude and frequency calibration from 0.01 to 22 GHz. The frequency span, bandwidth, and video filter are all coupled with automatic sweep to maintain a calibrated display and simplify use of the analyzer. Internal preselection eliminates most spurious responses to simplify signal identification. The preselector also extends the dynamic range of the analyzer as well as provides some protection for the input mixer. All major spectrum analyzer settings are displayed on the CRT bezel readout. The frequency range of the HP 8565A is 10 MHz to 22 GHz in direct coaxial input and 14.5 to 40 GHz when used with the HP 11517A External Mixer.

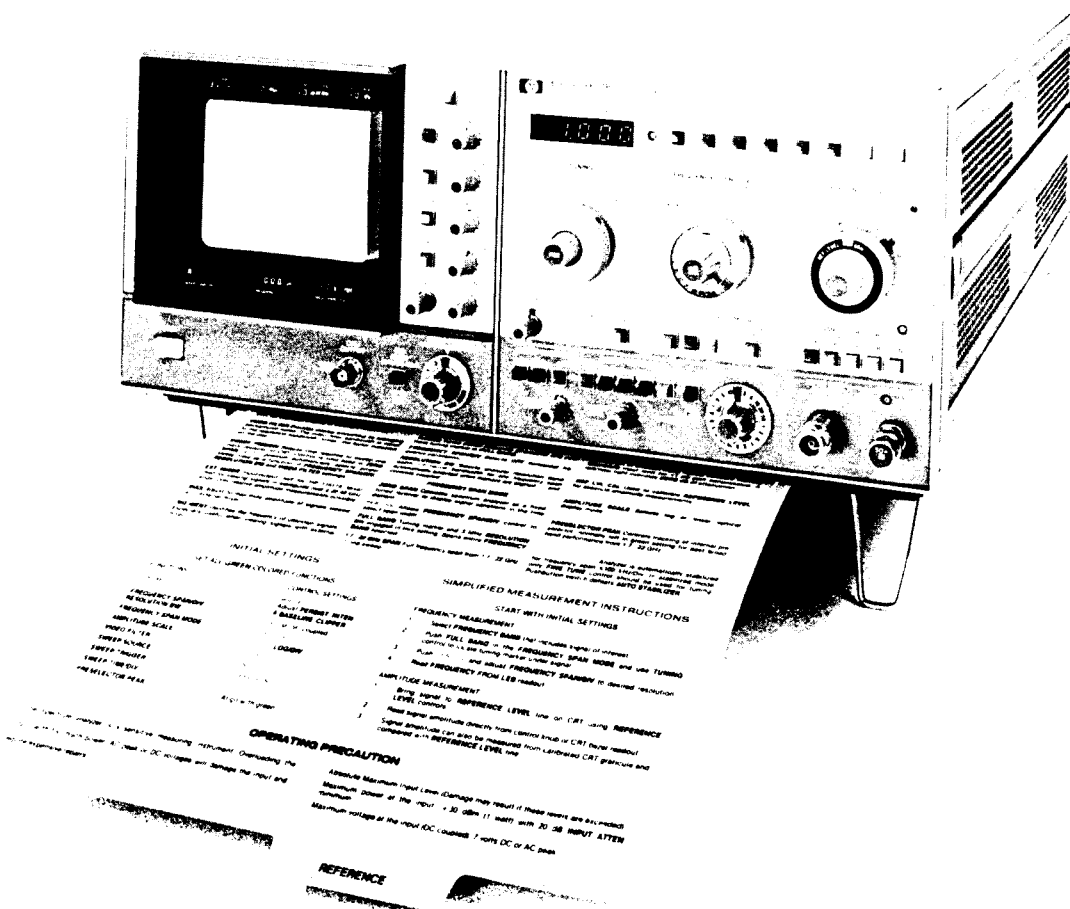

To aid in familiarization of the front panel controls, a fold-out illustration of the HP 8565A is included on page 24. Also any reference to the front panel controls are made in CAPITAL LETTERS.

# Chapter I

## OPERATING THE HP 8565A

The HP 8565A Spectrum Analyzer is a sensitive measuring instrument. To avoid damage to the instrument, do not exceed the following:

Absolute Maximum Inputs:<sup>1</sup>

**Total Power: +30 dBm (1 watt)**  
**DC: 0 V with 0 dB INPUT ATTEN**  
**±7 V with ≥ 10 dB INPUT ATTEN**  
**AC: (<<50 Ω nominal source impedance):**  
**0 V with 0 dB INPUT ATTEN**  
**10 V peak with ≥ 10 dB INPUT ATTEN**

### NORMAL SETTINGS

The Normal Settings are those settings which are used for the majority of measurements. For instance, 10 dB/DIV, INT sweep, and AUTO sweep time are most often used so they are classified as Normal Settings. All the Normal Settings on the HP 8565A are colored green so that the user can easily identify and set them initially. Table 1 lists all the green Normal Settings of the HP 8565A.

Table 1. Normal settings

Function	Setting
CRT DISPLAY	<input type="checkbox"/> WRITE
BASELINE CLIPPER	<input type="radio"/> OFF
FREQUENCY SPAN/DIV RESOLUTION BW	OPTIMUM (Push in) ▶ ◀ (to couple)
FREQUENCY SPAN MODE	<input type="checkbox"/> PER DIV
AMPLITUDE SCALE	<input type="checkbox"/> 10 dB/DIV
VIDEO FILTER	<input type="checkbox"/> OFF
SWEEP SOURCE	<input type="checkbox"/> INT
SWEEP TRIGGER	<input type="checkbox"/> FREE RUN
SWEEP TIME/DIV	<input type="checkbox"/> AUTO
PRESELECTOR PEAK	<input type="checkbox"/> Center in green area

With Normal Settings preset, most measurements can be made with just three knobs: TUNING, FREQUENCY SPAN/DIV, and REFERENCE LEVEL.

<sup>1</sup> For more detailed information regarding Operating Precautions, please refer to Appendix A.

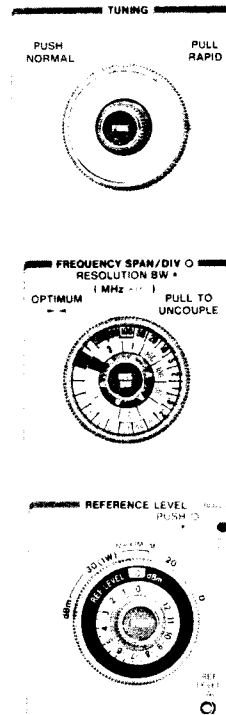

TUNING adjusts the center frequency of the analyzer. It also positions the marker in the full band modes.

FREQUENCY SPAN/DIV sets the horizontal frequency calibration on the CRT. An optimum RESOLUTION BW is automatically selected for a given frequency span.

The REFERENCE LEVEL control sets the vertical amplitude calibration on the CRT. The REFERENCE LEVEL (top graticule line) on the CRT represents an absolute power level (in dBm). Changes in RF INPUT ATTEN will also change the indicated REFERENCE LEVEL.

### SIMPLIFIED SIGNAL ANALYSIS



The internal CAL OUTPUT signal is a convenient source to demonstrate how fast and easy the HP 8565A can measure frequency and amplitude.

Start by presetting the green Normal Settings listed in Table 1, page 2. This sets the analyzer in its normal, three-knob operation mode. Now connect the CAL OUTPUT signal to the INPUT connector of the analyzer and begin the measurement procedure:

Initially, select the FREQUENCY BAND that includes the 100 MHz CAL OUTPUT signal:

Use the TUNING control to tune the 100 MHz signal to the center of the display. The FREQUENCY SPAN/DIV may be increased to facilitate tuning.

Once the signal is centered on the display, adjust the FREQUENCY SPAN/DIV to the desired resolution. Since there is no modulation on the CAL OUTPUT signal, a 1 MHz/DIV span is sufficient. Retune the signal to the center of the display if necessary.

Now position the peak of the signal on the REFERENCE LEVEL (top graticule line) of the CRT with the REFERENCE LEVEL control.

Since the CAL OUTPUT signal is the calibration reference for the analyzer, the center frequency should read 0.100 GHz and the REFERENCE LEVEL should read -10 dBm (Figure 2). If not, adjust the FREQ CAL and the REF LEVEL CAL to obtain the correct reading.<sup>2</sup>

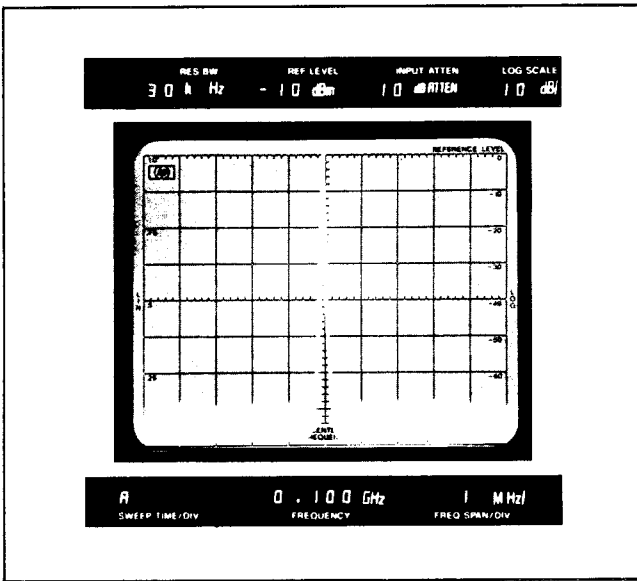

Figure 2. CAL OUTPUT signal

For this next example, let us suppose that the microwave source in the test set-up (Figure 3) operates in C-band (4 to 8 GHz). However, we do not know its exact output frequency. What, then, is the best way for locating a signal?

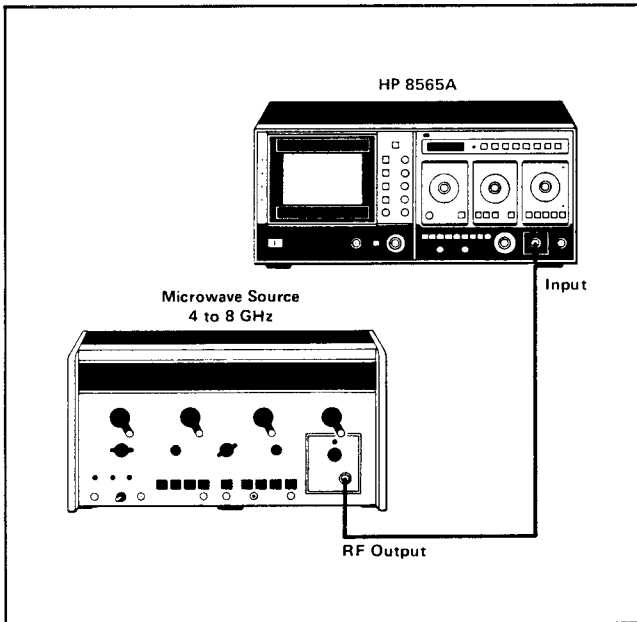

Figure 3. Microwave source test set-up

By using the FULL BAND feature of the HP 8565A, we can sweep an entire frequency band to search for a signal. Since we know that the microwave source in Figure 3 operates in C-band, the 3.8 to 8.5 GHz FREQUENCY BAND would be selected. A tuning marker (which appears in the full band modes) can be located under the signal to identify its frequency (Figure 4). Then by pushing the green PER DIV button, the signal at the marker will become the center frequency of the analyzer (Figure 5). In PER DIV the desired frequency span can be adjusted with the FREQUENCY SPAN/DIV control. Figure 6 graphically illustrates the procedure for locating a signal.

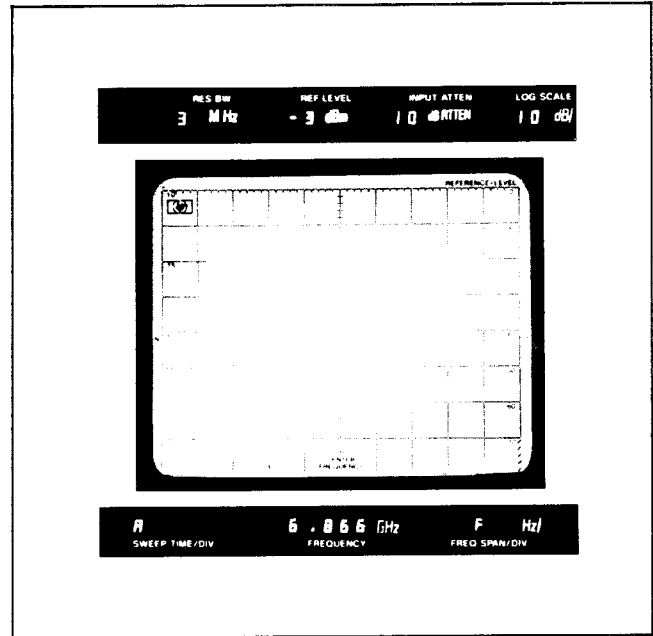

Figure 4. Tuning marker in FULL BAND

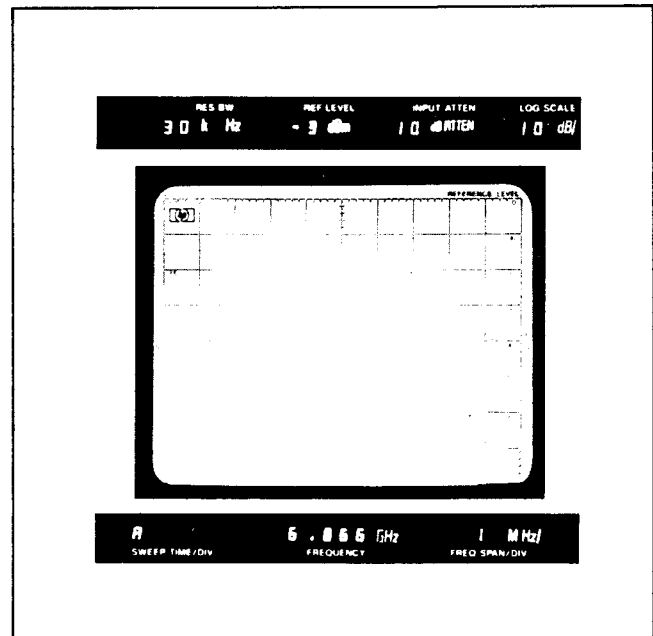
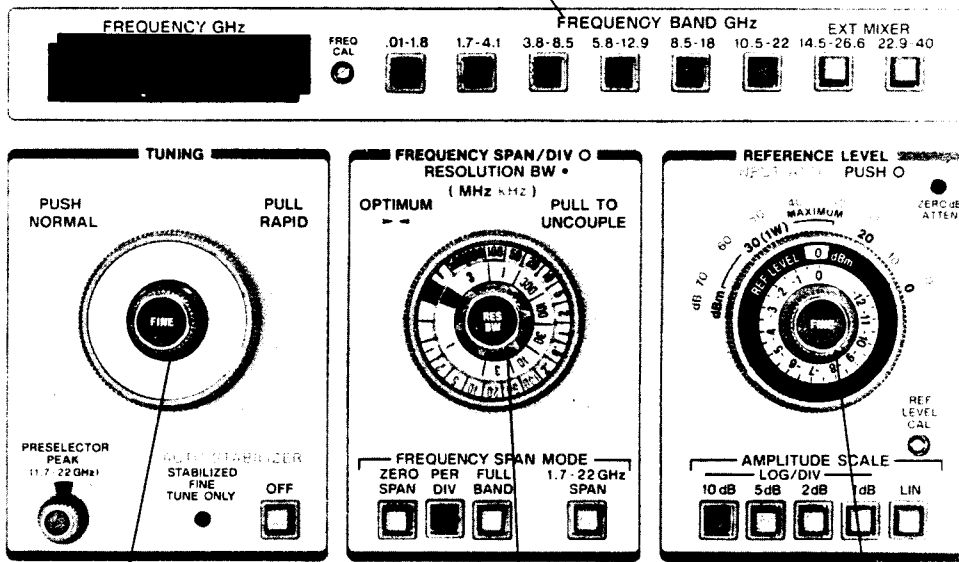

Figure 5. PER DIV mode

<sup>2</sup>A complete Front Panel Adjustment Procedure is included in Appendix C.

**1** Set desired FREQUENCY BAND while in FULL BAND Frequency Span Mode



**2** TUNING control sets marker which will be center frequency in PER DIV mode

**3** Reset to PER DIV and adjust FREQUENCY SPAN/DIV

**4** Position signal on top REFERENCE LEVEL line

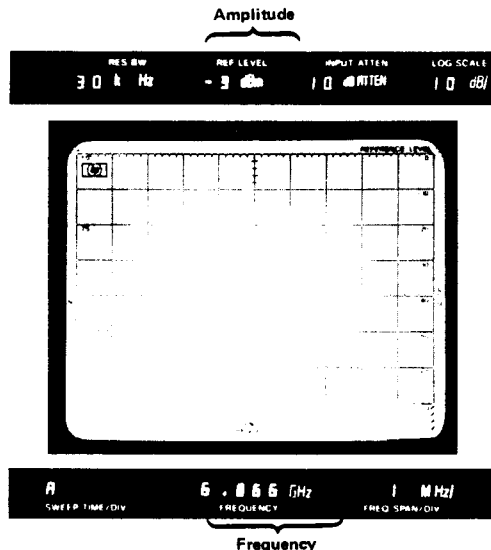

Figure 6. Locating a signal



# Chapter 2

## DETAILED CONTROL OPERATION

### TUNING

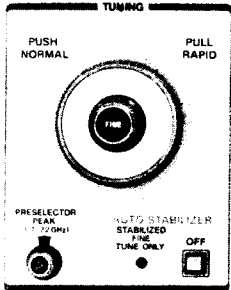

The TUNING control adjusts the center frequency of the analyzer. In the full band modes, the TUNING control is used to locate a marker under a particular signal. The FREQUENCY readout indicates the center frequency of the analyzer or the frequency at the tuning marker. By pulling out the outer control knob, *rapid* tuning is enabled. Rapid tuning is especially useful when moving the tuning marker in

the full band modes. Normal tuning resumes when the knob is pushed in. When the analyzer is stabilized (frequency span  $\leq 100$  kHz/Div) only FINE TUNING should be used to tune the analyzer. If coarse tuning is desired, the AUTO STABILIZER can be disabled with the pushbutton switch.

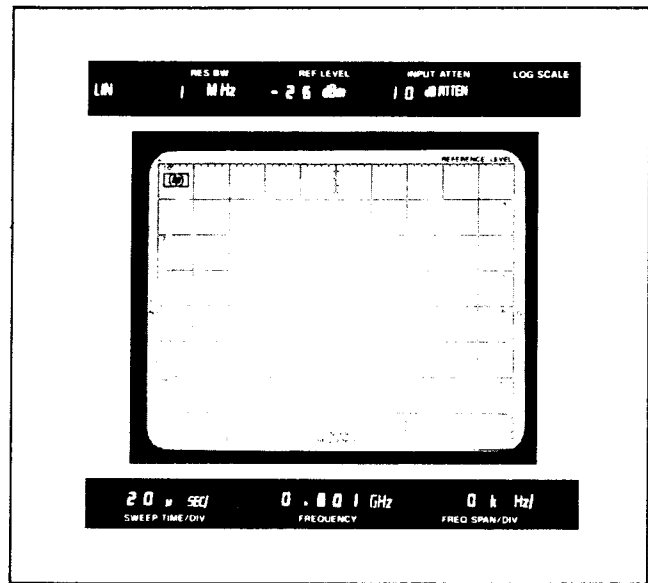

Figure 7. AM carrier demodulated in ZERO SPAN

### FREQUENCY SPAN MODES



Four pushbutton span modes are available on the HP 8565A: ZERO SPAN, PER DIV, FULL BAND, and 1.7 - 22 GHz SPAN. Also, an additional F (full-band) setting is

available on the FREQUENCY SPAN/DIV control knob. The full band modes, (FULL BAND, F, and 1.7 - 22 GHz SPAN) enable the analyzer to monitor the various frequency bands as well as a multi-octave coverage from 1.7 to 22 GHz. PER DIV is generally used for detailed signal analysis and ZERO SPAN is used for time domain analysis. The following text explains the various FREQUENCY SPAN MODE settings in more detail.

#### Zero Span

ZERO SPAN is used when it is desired to recover the modulation on a carrier. In ZERO SPAN there is no sweep voltage applied to the LO in the analyzer; hence, it operates as a manually-tuned receiver. Carrier modulation will be displayed in the time domain and the calibrated SWEEP TIME/DIV control can be used manually to read the time variation of the signal. Selecting VIDEO trigger will allow the sweep to be synchronized on the demodulated waveform. Figure 7 is a display of a demodulated AM carrier that was obtained with the analyzer in ZERO SPAN.

Since the analyzer remains calibrated in ZERO SPAN, it is also possible to measure the amplitude and frequency of a CW signal. In this case, the CW signal appears as a horizontal line on the CRT (see Figure 8). Using a wide RESOLUTION BW setting and disabling the AUTO STABILIZER will allow the signal to be tuned to easily.

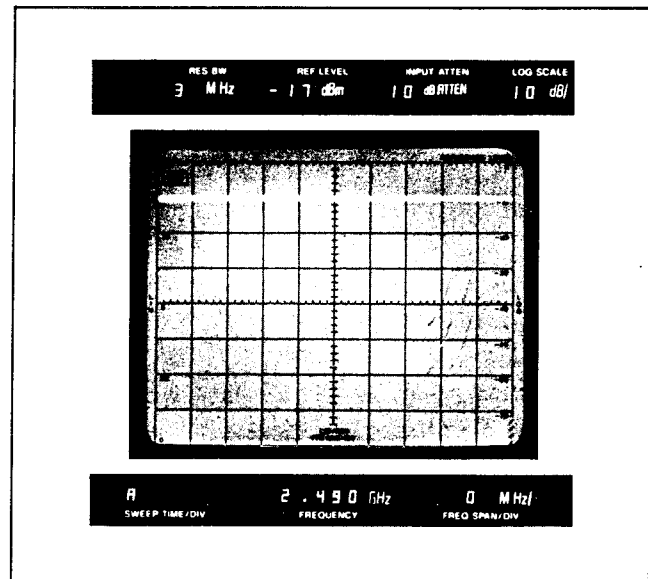

Figure 8. CW measurement in ZERO SPAN

#### Per Div

The PER DIV mode enables the FREQUENCY SPAN/DIV control to set the horizontal frequency calibration of the CRT. The calibrated FREQUENCY SPAN/DIV control is adjustable from 1 kHz/DIV to 500 MHz/DIV. Also, an F (full band), position is available which allows the entire FREQUENCY BAND selected to be scanned. Normally, the RESOLUTION BW is optimally coupled ( $\blacktriangle\blacktriangleleft$ ) to the FREQUENCY SPAN/DIV. Then the optimum RESOLUTION BW is automatically selected as the FREQUENCY SPAN/DIV is adjusted.

### Full Band

The FULL BAND mode scans the entire FREQUENCY BAND selected in one sweep. A tuning marker, 3 MHz RESOLUTION BW and 0.003 VIDEO FILTER are automatically set in FULL BAND. Different FREQUENCY BANDS can be selected to look for unknown signals. Once a signal is located in a particular FREQUENCY BAND, the tuning marker can be positioned under the signal to identify its frequency (Figure 9). Then, by pushing PER DIV, the signal that was at the marker will be displayed as the

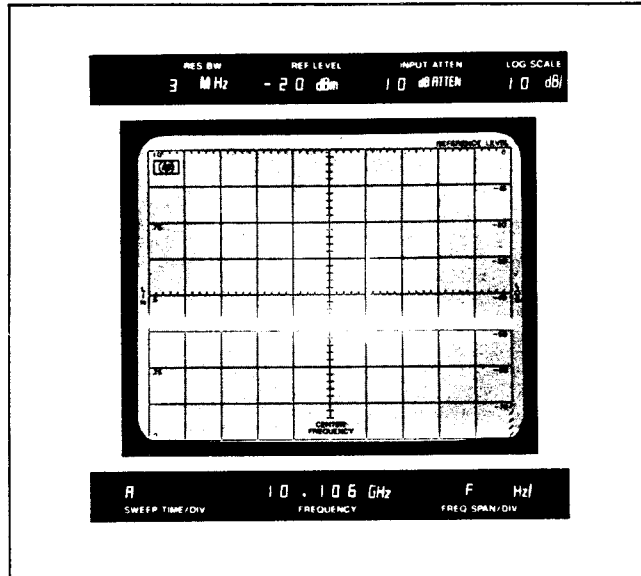

Figure 9. Identifying a signal in FULL BAND

center frequency on the CRT (Figure 10). The F position on the FREQUENCY SPAN/DIV control differs from the FULL BAND pushbutton in that it allows independent adjustment of RESOLUTION BW and VIDEO FILTER.

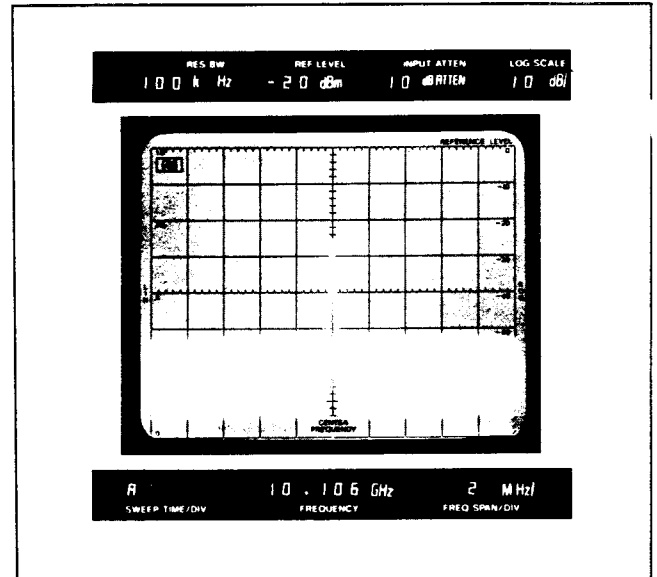

Figure 10. Analysis in PER DIV

### 1.7 - 22 GHz Span

A multi-band sweep is available when the 1.7 - 22 GHz SPAN pushbutton is depressed. This span mode is useful for observing signal activity within a broad frequency range. A tuning marker can be used with rapid TUNING to quickly identify the frequency of any signal in the 1.7 to 22 GHz range. Figure 11 illustrates a typical display using the 1.7 - 22 GHz SPAN mode.

The staircase baseline display is the result of gain compensation applied to the higher frequency bands to maintain a calibrated amplitude display. Gain compensation is required because the higher frequency bands utilize higher LO harmonics which yields reduced sensitivity.<sup>3</sup>

Table 2. Frequency Span Modes

	Full Band Modes				
	ZERO SPAN <input type="checkbox"/> (Time Domain)	PER DIV <input type="checkbox"/> (Close Analysis)	<input checked="" type="checkbox"/> On Freq Span/Div Control	FULL BAND <input type="checkbox"/>	1.7 - 22 GHz SPAN <input type="checkbox"/>
TUNING MARKER	NO	NO	YES	YES	YES
FREQUENCY SPAN	ZERO (Manual Tune)	Selectable from 1 kHz/DIV to 500 MHz/DIV	Depends on FREQUENCY BAND Selected	Depends on FREQUENCY BAND Selected	1.7 to 22 GHz
RESOLUTION BANDWIDTH	Selectable	OPTIMUM (▶◀) or Selectable	Selectable	Fixed at 3 MHz	Fixed at 3 MHz
VIDEO FILTER	Selectable	Selectable	Selectable	Fixed at 0.003 x 3 MHz = 9 kHz	Fixed at 0.003 x 3 MHz = 9 kHz

<sup>3</sup> To obtain the highest sensitivity from the analyzer, use the lowest FREQUENCY BAND available when there is a frequency overlap. For instance, a 7 GHz signal can be measured in the 3.8 to 8.5 GHz band or the 5.8 to 12.9 GHz band. The sensitivity however, is better in the 3.8 to 8.5 GHz band.

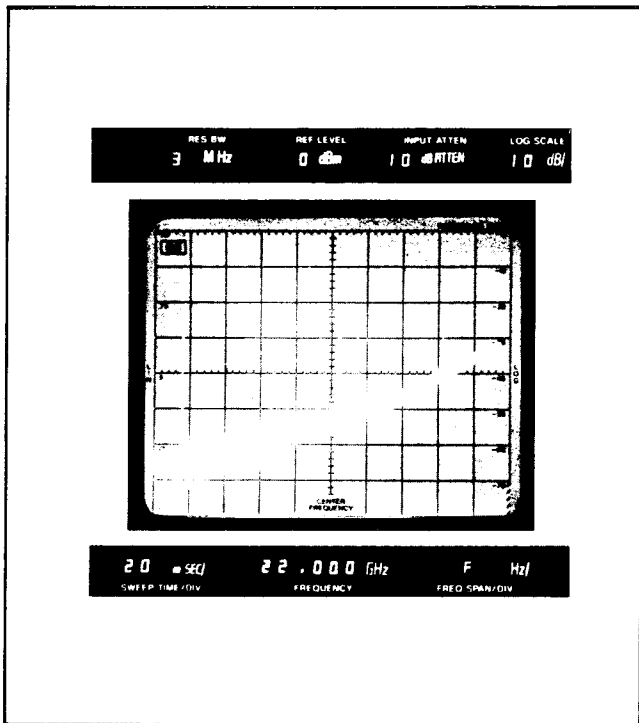
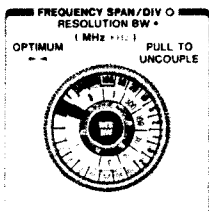

Figure 11. 1.7 - 22 GHz SPAN mode

The five frequency span modes available on the HP 8565A provide the user with maximum flexibility in making measurements. Table 2 summarizes the characteristics of each FREQUENCY SPAN MODE.

## RESOLUTION BANDWIDTH



In Normal Setting, the RESOLUTION BW is optimally coupled to the FREQUENCY SPAN/DIV by aligning the green markers (▶◀) and pushing the controls in to couple. Once the controls are coupled at OPTIMUM, the best RESOLUTION BW will be automatically chosen for any frequency span selected.

The RESOLUTION BW can also be coupled at a position other than OPTIMUM.

For certain applications, independent control of RESOLUTION BW may be desirable. By pulling out either control knob, the RESOLUTION BW will be decoupled thus allowing different RESOLUTION BW settings to be selected. Figure 12 illustrates how an AM signal with 200 kHz sidebands is displayed with various RESOLUTION BW settings. Also, note that the narrower RESOLUTION BW will yield increased sensitivity since random noise decreases 10 dB for every factor of 10 reduction in RESOLUTION BW.

The SWEEP TIME/DIV, when in AUTO position, will automatically select the proper sweep speed whether the RESOLUTION BW is coupled or uncoupled and operated independently.

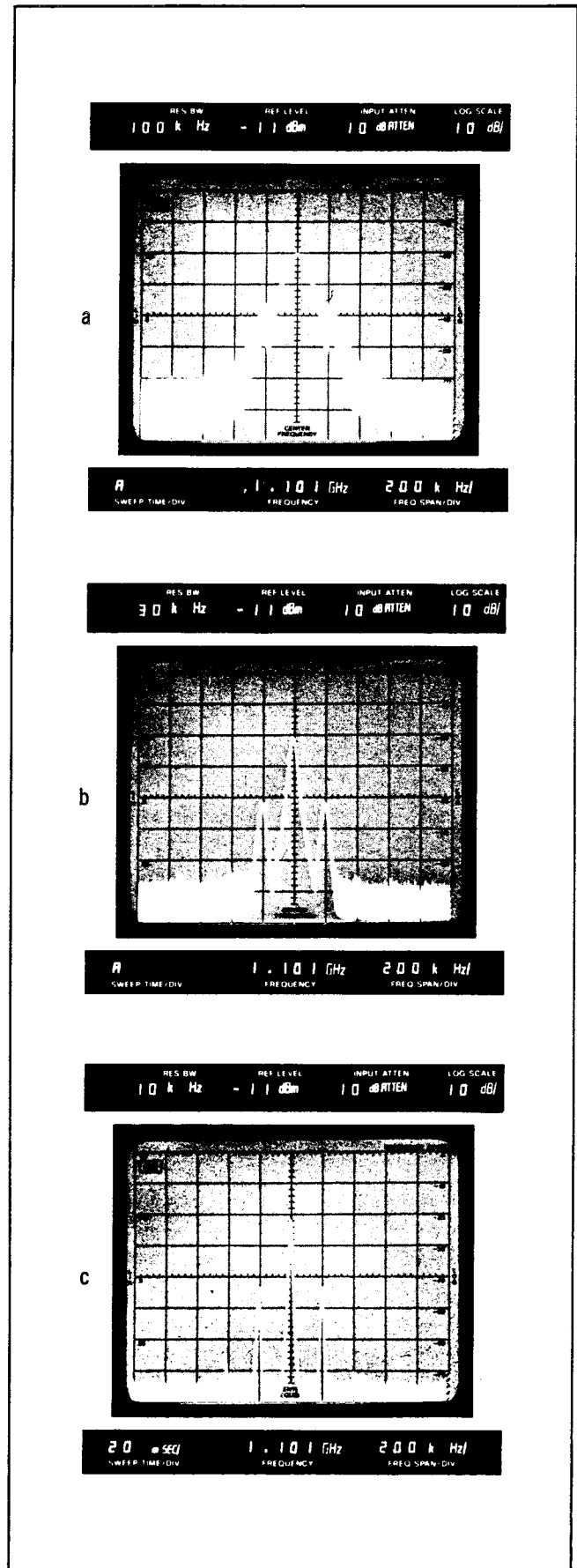
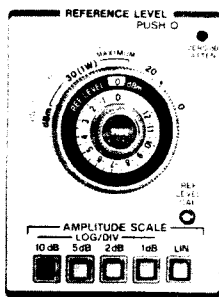

Figure 12. (a) 100 kHz RBW (b) 30 kHz RBW (c) 10 kHz RBW

# REFERENCE LEVEL



The main purpose of the REFERENCE LEVEL control is to set the absolute power of the REFERENCE LEVEL (top graticule line) on the CRT. When the peak of a signal is at the REFERENCE LEVEL, its absolute power (in dBm) will be indicated on the bezel readout as well as on the REFERENCE LEVEL control knob.

The REFERENCE LEVEL control, along with the INPUT ATTEN, has a range of 172 dB; from -102 dBm to +70 dBm. Although the REFERENCE LEVEL is cali-

brated from +30 to +70 dBm, signal levels should never exceed +30 dBm since that is the maximum power the analyzer can withstand without damage. In Figure 13, the REFERENCE LEVEL was adjusted to position  $f_1$  on the REFERENCE LEVEL line of the CRT. The absolute power of  $f_1$  then, is +30 dBm. The level at  $f_2$  can be read from the calibrated CRT display as +30 dBm - 50 dB = -20 dBm. If desired, a low-level signal can be positioned on the REFERENCE LEVEL line to read its power level directly on the bezel readout as on the REFERENCE LEVEL control knob.

The REFERENCE LEVEL line on the CRT is determined by a combination of IF gain (REFERENCE LEVEL control) and RF attenuation (INPUT ATTEN). The outer control knob adjusts the IF gain in 10 dB steps. A FINE vernier knob provides continuous control from 0 to -12 dB.

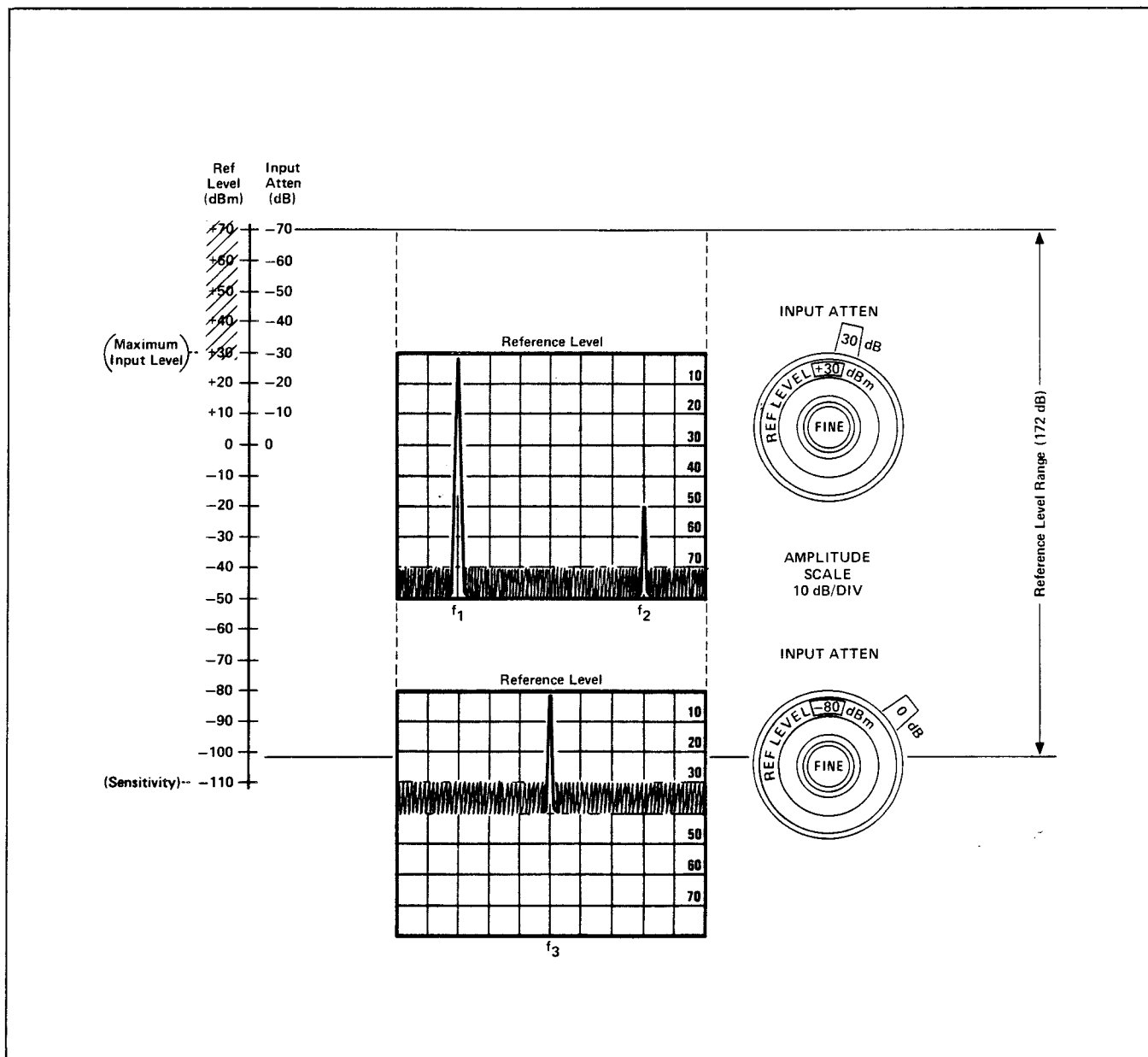
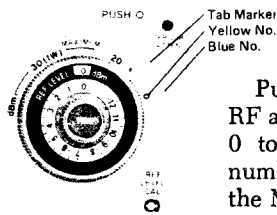

Figure 13. REFERENCE LEVEL control diagram



Pushing the outer knob in allows RF attenuation (blue numbers) from 0 to 70 dB to be selected. The numbers outlined in yellow indicate the MAXIMUM signal input allowable prior to signal compression.

A reminder light is lit whenever 0 dB INPUT ATTEN is selected. Unless making noise measurements or when maximum sensitivity is required, a minimum INPUT ATTEN of 10 dB should always be used. This insures a good input SWR and will minimize uncertainties due to mismatches.

### VIDEO FILTER



The VIDEO FILTER control is used to average the noise displayed on the CRT. The VIDEO FILTER bandwidth is equal to the dial factor indicated multiplied by the RESOLUTION BW setting.

i.e. RESOLUTION BW = 30 kHz,  
VIDEO FILTER = 0.01  
then VIDEO FILTER = 0.01 x 30 kHz = 300 Hz.

If the RESOLUTION BW is changed to 10 kHz the VIDEO FILTER bandwidth will be 100 Hz. Thus, the VIDEO FILTER always varies as a percentage of the RESOLUTION BW.

The VIDEO FILTER is useful when observing a low-level signal that is close to the noise level. Figure 14 illustrates how use of the VIDEO FILTER control enables a low-level signal, close to the noise level, to be seen more clearly.

In addition, a NOISE AVG position on the VIDEO FILTER control allows the analyzer to make noise level measurements or to measure its own sensitivity (in a given RESOLUTION BW). The NOISE AVG position engages a 1 Hz low-pass filter to average the noise displayed on the CRT. Also the sweep time of the analyzer is increased to facilitate making noise level measurements.<sup>4</sup>

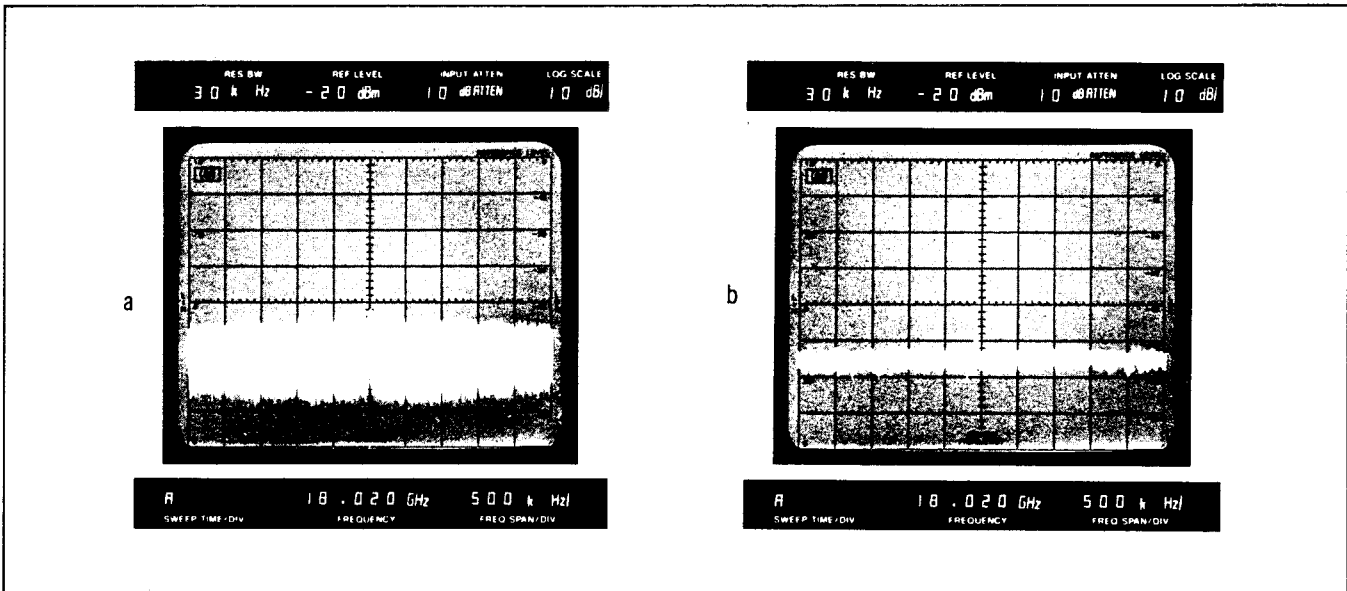
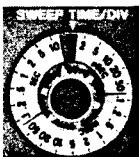

Figure 14. (a) VIDEO FILTER off (b) VIDEO FILTER = 0.003 x 0.10 kHz = 30 Hz

### AUTOMATIC SWEEP TIME



In the green AUTO position, the sweep time is automatically adjusted for any FREQUENCY SPAN/DIV, RESOLUTION BW, and VIDEO FILTER selected to maintain a calibrated amplitude display. One way to see the effect of

AUTO SWEEP TIME/DIV is by decreasing the VIDEO FILTER bandwidth. The sweep rate will slow down automatically to allow the narrow VIDEO FILTER bandwidths more time to respond. Calibrated sweep times from 2  $\mu$ sec/DIV to 10 sec/DIV are available when the SWEEP TIME/DIV control is switched out of the AUTO position and operated manually. The faster sweep times (2  $\mu$ sec/DIV to 1 msec/DIV) are used only to display fast signal

variations in the time domain (ZERO SPAN). A word of caution is necessary if the SWEEP TIME/DIV control is operated manually in PER DIV or in any full band modes. To insure that the amplitude calibration in the analyzer is maintained, observe changes in signal amplitude as the SWEEP TIME/DIV is changed. If the signal amplitude does not change, then the SWEEP TIME/DIV chosen is sufficient to allow the analyzer's bandwidth filters to fully respond. Additionally, the SWEEP TIME/DIV (AUTO or manual operation) will operate with any type of SWEEP TRIGGER as long as the INTERNAL SWEEP SOURCE is selected.

<sup>4</sup> Because of detector and log amplifier characteristics, 2.5 dB should be added to obtain the correct noise power reading. See Hewlett-Packard Application Note 150-4 for details.

# Chapter 3

## SPECIAL TOPICS

### OPTIMUM DYNAMIC RANGE

Dynamic range is defined here as the ratio of the largest signal to the smallest signal that can be at the input simultaneously with no analyzer distortion products. The "optimum" dynamic range is the point where the maximum distortion-free dynamic range can be achieved along with the maximum signal-noise ratio.

The optimum dynamic range on the HP 8565A can be determined by referring to Figure 17 on page 11. Three types of curves are presented on the chart; sensitivity (solid line), second-order distortion (dash line) and third-order distortion (dotted line). The sensitivity curves for the six internal frequency bands (0.01 - 22 GHz) have been normalized to a 1 kHz bandwidth. To use the sensitivity curves for different resolution bandwidths, simply subtract 10 dB from the signal-noise ratio reading for every factor of 10 increase in resolution bandwidth (i.e., a signal-noise ratio of 70 dB for a 1 kHz bandwidth would be 60 dB for a 10 kHz bandwidth). The second-order and third-order distortion curves are dependent on whether the 0.01 to 1.8 GHz or the 1.7 to 22 GHz frequency bands are used. Two vertical axes are used in Figure 17: Signal-Noise Ratio (left side) and Distortion-Free Dynamic Range (right side). The optimum dynamic range occurs at the intersection of the particular sensitivity and distortion curve under consideration. At this point the maximum Distortion-Free Dynamic Range is achieved with the maximum Signal-Noise Ratio.

Three major factors determine the optimum achievable dynamic range of the HP 8565A. They are:

1. Effective signal input
2. Frequency band
3. Signal separation

Let's examine each of these factors separately.

#### Effective Signal Input

The Effective Signal Input is simply the signal at the input minus the analyzer INPUT ATTEN setting. In equation form:

$$\text{Effective Signal Input} = \text{signal input} - \text{INPUT ATTEN.}$$

The horizontal axis on the dynamic range chart represents the Effective Signal Input.

Dynamic range varies as a function of Effective Signal Input. This is not as critical in the preselected 1.7 to 22 GHz frequency range. However, in the 0.01 to 1.8 GHz range, the Effective Signal Input (for optimum dynamic range) should be approximately  $-40$  dBm when measuring second-order distortion products. Beyond this level, second-order distortion will increase 20 dB for every 10 dB increase in signal input. For third-order distortion measurements, the Effective Signal Input should be ap-

proximately  $-30$  dBm. The optimum dynamic range in the 1.7 to 22 GHz band is achieved with an Effective Signal Input of approximately 0 dBm. This applies for both second-order and third-order distortion products.

Example: (Refer to Figure 17 on page 11.)

It is desired to measure the third-order distortion products from a device. The input signals are at 1456 MHz and 1466 MHz. Find the Effective Signal Input to obtain the optimum dynamic range.

Answer: The Effective Signal Input to achieve this is  $-30$  dBm for each signal. Since this is a third-order measurement, we use the dotted third-order distortion curve applicable to the frequency range. Intersect this curve with the sensitivity curve that covers 0.01 to 1.8 GHz. The optimum dynamic range occurs at the intersection of the curves.

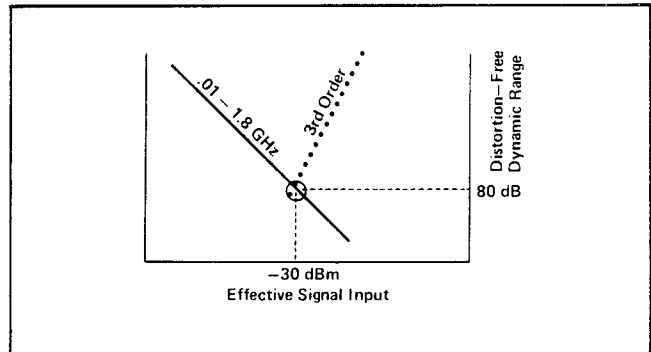

#### Frequency Bands

It can be seen that the dynamic range for the 1.7 to 22 GHz frequency range is generally much greater than for the 0.01 to 1.8 GHz range. This benefit is possible due to the tracking preselector in the HP 8565A. The preselector extends the dynamic range by allowing the analyzer to measure a low-level signal in the presence of a potentially interfering high-level signal. Since the preselector tracks the tuning of the analyzer, it only allows a signal to pass to the mixer when both preselector and analyzer are tuned to receive it. When the analyzer is tuned to the low-level harmonic, the preselector rejects the high-level fundamental, thus preventing internal distortion products from affecting the measurement.

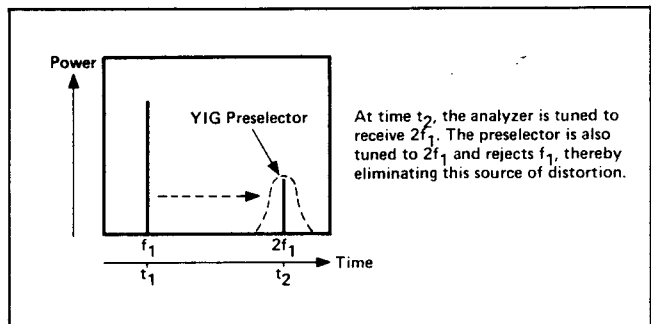

Figure 15. YIG preselector tuning

### Signal Separation

In the preselected frequency bands (1.7 to 22 GHz) the tracking bandpass filter has a nominal 50 MHz bandwidth. For signal separation >100 MHz, the tracking filter will only allow one signal to pass to the mixer while simultaneously rejecting the other signal. This is illustrated in Figure 16: Since only one signal enters the analyzer at any instant in time, the analyzer will not generate any third-order distortion products. Also, for larger signal separation, the preselector will have more rejection and hence the dynamic range is greater.

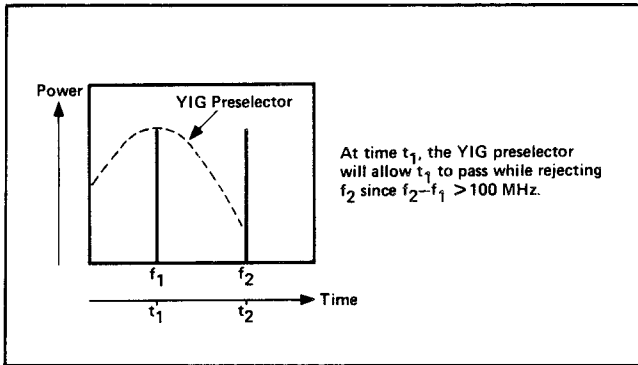

Figure 16. YIG preselector passband

### Example:

It is desired to measure the third-order intermodulation products of a microwave amplifier. The two output signals are -10 dBm at 5.9 and 6.1 GHz. What is the dynamic range of the analyzer?

Answer: 93 dB. Find the sensitivity curve for 3.8 to 8.5 GHz. Intersect this with the effective signal input at -10 dBm. The dynamic range of the analyzer is 93 dB.

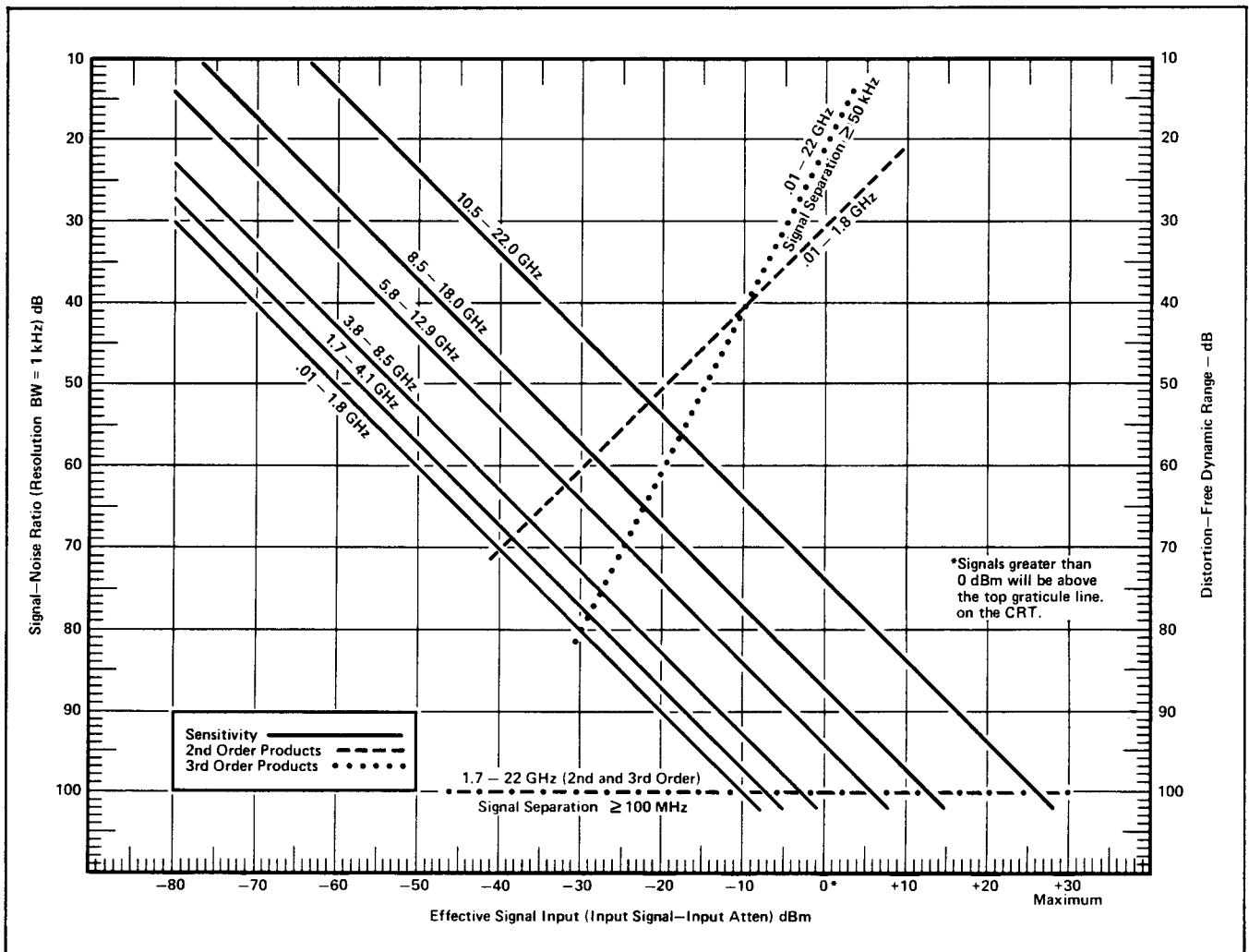
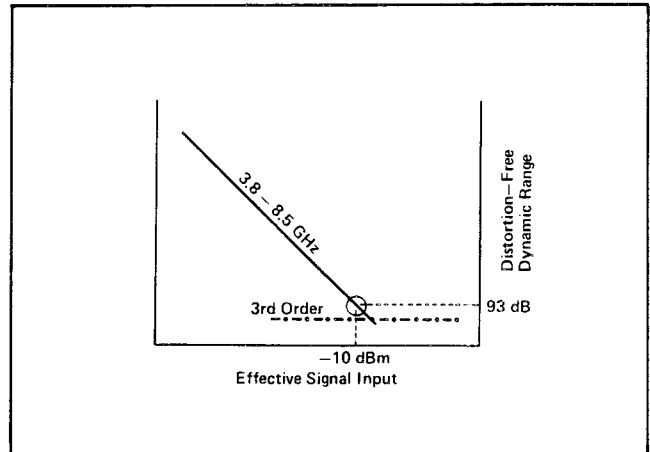

Figure 17. Dynamic range

Other constraints: When measuring distortion products associated with low-level signal inputs, the available signal strength will be the limitation. In this case, find the signal level on the Effective Signal Input (horizontal) axis and go vertically to the appropriate sensitivity curve. The maximum obtainable dynamic range is read from the Signal-Noise Ratio (vertical) axis.

## IMPROVING MEASUREMENT ACCURACY

The technique known as IF substitution can be used to improve measurement accuracy on the HP 8565A. IF substitution is a method of using *only* the accurate IF gain of the analyzer to position the signal on the calibrated REFERENCE LEVEL line. In this way, errors due to the CRT non-linearity, log amplifier, input attenuator, and bandwidth filter will be eliminated. The IF gain of the analyzer is controlled with the calibrated REFERENCE LEVEL knob. The steps for achieving accurate amplitude measurements with IF substitution are as follows:

### Amplitude Measurement With IF Substitution

1. Set the INPUT ATTEN to 10 dB or greater. This insures a good input SWR to minimize mismatch errors.
2. Set the FREQUENCY SPAN/DIV control to the desired frequency resolution.
3. Connect the CAL OUTPUT signal to the analyzer to verify calibration.
4. Disconnect the CAL OUTPUT signal and connect the signal to be measured.
5. Set the desired FREQUENCY BAND and use *only* the TUNING control to center the signal on the CRT.
6. In the 1.7 to 22 GHz frequency range, adjust the PRESELECTOR PEAK control to maximize the signal level.<sup>5</sup>
7. Now, using only the REFERENCE LEVEL control and FINE vernier, position the peak of the signal on the REFERENCE LEVEL line of the CRT. The signal amplitude is indicated by the REF LEVEL on the CRT bezel readout.

When the IF substitution technique is used for amplitude measurements, the only remaining measurement uncertainties are due to the CAL OUTPUT signal, flatness, and REFERENCE LEVEL control of the analyzer. Uncertainties due to RESOLUTION BW, INPUT ATTEN, log amplifier, and CRT non-linearities have been eliminated because they were left unchanged throughout the measurement.

<sup>5</sup> Normally, the best broadband tracking performance of the preselector is obtained with the PRESELECTOR PEAK control centered in the green area. However, for accurate power measurement, the PRESELECTOR PEAK control should be adjusted to maximize signal level.

Further accuracy improvement can be achieved by calibrating the analyzer at the same frequency to which the measurement will be made. This would eliminate any flatness uncertainties and the measurement accuracy would only be dependent upon the accuracy of the calibration signal and the REFERENCE LEVEL control.

## CRT PHOTOGRAPHY AND X-Y RECORDING

### CRT Photography

The CRT bezel readout on the HP 8565A provides an excellent means of information retention with use of any compatible scope camera. Since the display has readouts for all major spectrum analyzer settings, the need for additional writing on the photograph is largely eliminated. Also, interference between trace and characters is not a problem since the LED's are built into the CRT bezel. (See Figure 18.)

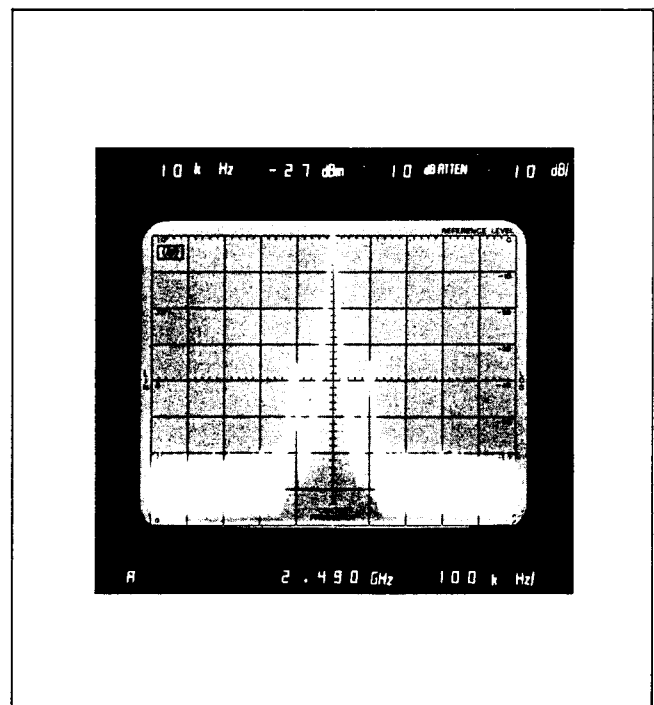

Figure 18. CRT display with bezel readout

The photo in Figure 18 is a double exposure which was taken with a camera that has variable shutter speed and f-stop. A double exposure provides the best contrast between signal trace, graticule lines, and CRT bezel readout. A step-by-step procedure for double-exposure photography is given below. These steps are applicable with the HP 197A or other compatible scope cameras:

### Double Exposure Photography

1. Set the HP 8565A STORE INTEN and SCALE INTEN to the calibrated blue markings.
2. Set the camera shutter speed to 1 second and the f-stop to 16.



3. Push the STORE button on the analyzer to store the trace.<sup>6</sup> Press shutter on camera to take first exposure.
4. Push the SCALE button on the analyzer to illuminate the graticule lines.<sup>7</sup> Wait 2 seconds for display to fully erase. Press shutter on camera to take second exposure.

### X-Y Recording

The HP 8565A is directly compatible with HP's line of X-Y recorders as well as strip-chart, digital, or magnetic tape recorders. The VERTICAL OUTPUT, BLANK OUTPUT, and HORIZONTAL SWEEP OUTPUT are all available from the rear panel of the analyzer. X-Y recorders can provide full-size (up to 11" x 14") copies with high resolution that are more applicable for folders or lab reports. Also, they can be reproduced easier than photographs and thus provide additional copies at minimal cost. Figure 19 illustrates a typical set-up used for X-Y recording.

The bandwidth of most X-Y recorders is very narrow; typically 1 to 2 Hz. This narrow bandwidth requires a sweep rate that is slow enough for the recorder to fully respond to a signal. In general, a sweep rate of 2 sec/div is sufficient for the majority of X-Y recorders. The SINGLE or the MANUAL sweep mode on the HP 8565A can be used to control the sweep.

Additional detailed information on CRT Photography and X-Y recording can be obtained from Hewlett-Packard Application Note 150-5.

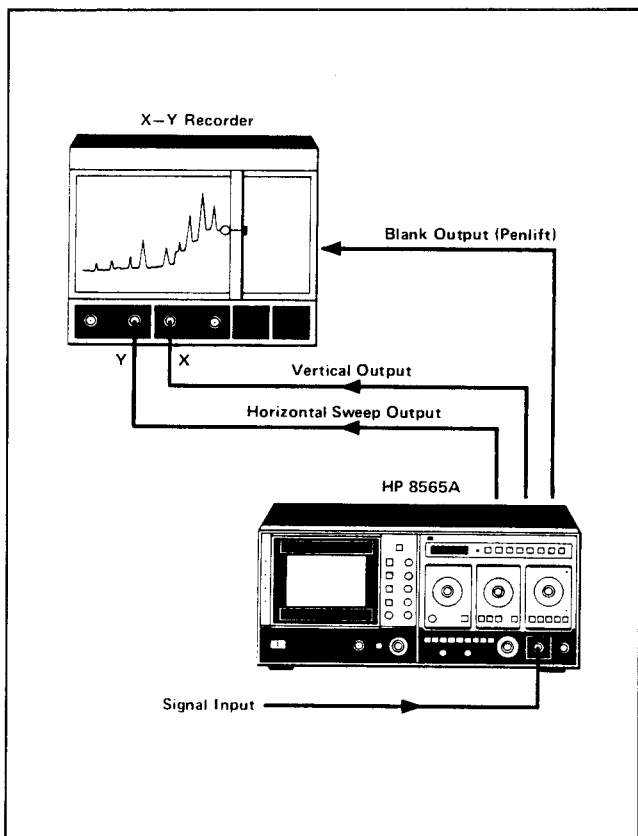

Figure 19. X-Y recording

<sup>6</sup> When the STORE or SCALE button is pushed, the FREQUENCY readout on the CRT bezel is fixed in its last reading. This insures that the FREQUENCY reading will not change while the camera shutter is opened.

<sup>7</sup> The SCALE button simultaneously erases the trace and illuminates the graticule lines.

### EXTERNAL MIXER OPERATION

Calibrated frequency coverage from 14.5 to 40 GHz can be achieved by using the HP 11517A External Mixer with the appropriate waveguide adapter listed in Table 3. The external mixer connects to the EXT MIXER port on the front panel of the HP 8565A with a BNC coaxial cable. Setting the corresponding FREQUENCY BAND will allow frequency coverage in two ranges: 14.5 to 26.6 GHz or 22.9 to 40 GHz.

Table 3. External mixer components

HP Model Number	Description	HP Band Designation
11517A	12.4 - 40 GHz Mixer	P K R
11518A	12.4 - 18 GHz Adapter	
11519A	18 - 26.5 GHz Adapter	
11520A	26.5 - 40 GHz Adapter	

A connection diagram of the HP 8565A with the HP 11517A External Mixer and adapter is illustrated in Figure 20.

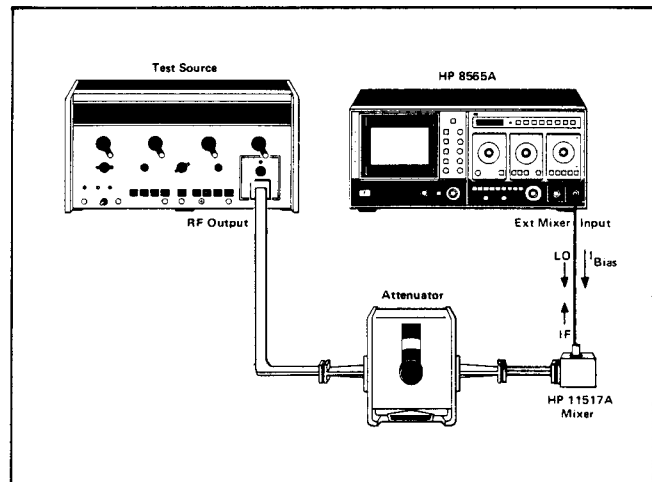

Figure 20. External mixer test set-up

The EXT MIXER port is somewhat unique in that it transceives three signals. The LO and a bias current ( $I_{bias}$ ) exit to the HP 11517A and the IF is received back at the EXT MIXER port. Filter networks at the EXT MIXER port separate the unwanted RF signals from the desired IF product. The BIAS control is adjusted to optimize the signals viewed with the external mixer.

In operation, the HP 11517A External Mixer bypasses the input attenuator, preselector, and the calibrated internal mixer of the analyzer. Hence, three things must be remembered when using the external mixer:

1. The INPUT ATTEN has no effect on input signals.
2. Harmonic mixing responses must be properly identified since there is no preselection in the EXT MIXER bands.

- Amplitude measurements are uncalibrated unless steps are taken to calibrate the analyzer.

### Signal Identification

To properly identify a signal on the CRT, the SIG IDENT on the HP 8565A is used. To use the SIG IDENT, center the unknown response on the CRT and set the FREQUENCY SPAN/DIV to 1 MHz. Then depress the SIG IDENT pushbutton and note if the response resembles Figure 21. If the response moves two divisions to the left and drops in amplitude, then it is the correct signal and its frequency is indicated on the LED display. If the response does not identify correctly, then tune to another response and use the SIG IDENT once again to identify it.

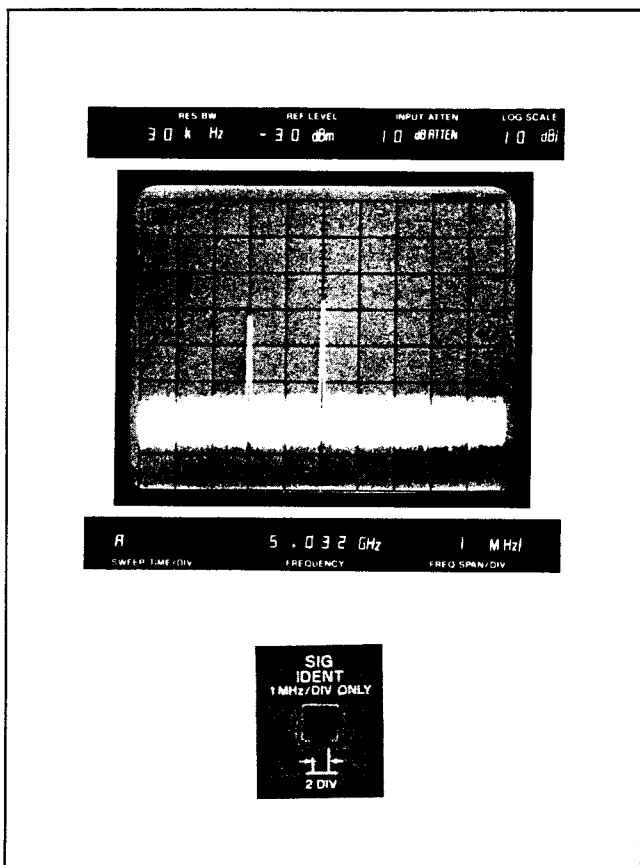

Figure 21. Signal identifier

### Amplitude Calibration of External Mixer

The analyzer can easily be calibrated to read absolute power if a reference signal is available in the frequency range of interest. This is done by using both the INPUT ATTEN control and the REF LEVEL CAL adjustment on

the analyzer. Since the INPUT ATTEN is bypassed in EXT MIXER operation, it has no effect on the signal but will change the REF LEVEL readout. Thus the INPUT ATTEN control provides a method of calibrating the analyzer to within  $\pm 5$  dB (attenuator has 10 dB steps) of the reference signal. To adjust between the  $\pm 5$  dB limit, use the REF LEVEL CAL adjustment to bring the display into an absolute power calibration. A step-by-step procedure for calibrating the analyzer to measure absolute power up to 40 GHz with the HP 11517A mixer follows:

### Procedure

- Set up equipment as shown in Figure 20.
- Connect reference signal to external mixer and select corresponding EXT MIXER frequency band to be calibrated.
- Use SIG IDENT to verify that reference signal is correct response.
- Peak the reference signal displayed on the analyzer with the BIAS control. Adjust to the maximum peak since it is normal to see more than one peak occur.
- Set the INPUT ATTEN to 0 dB and the REF LEVEL FINE control to 0 dB.
- Position the reference signal as close as possible to the REFERENCE LEVEL line using only the coarse REFERENCE LEVEL control.
- Since the amplitude of the reference signal is known, adjust the INPUT ATTEN to obtain the correct amplitude reading on the CRT bezel readout. If the reference signal is not in *even* 10 dB increments (i.e.,  $-20$  dBm,  $-30$  dBm) then it will be necessary to adjust the REF LEVEL FINE control to obtain the correct REF LEVEL readout.
- At this point, the REF LEVEL readout on the bezel should read the amplitude of the reference signal. Also, the signal should be positioned within  $\pm 5$  dB of the REFERENCE LEVEL line. The final step is to position the reference signal on the REFERENCE LEVEL line by using the REF LEVEL CAL adjustment.

Once the reference signal is at the REFERENCE LEVEL line and the REF LEVEL reading equals the absolute value of the reference signal, the analyzer will be amplitude calibrated for that particular EXT MIXER band.

Note: If the REF LEVEL CAL adjustment was used to calibrate the EXT MIXER band, then the analyzer must be recalibrated to its internal CAL OUTPUT signal for the 0.01 to 22 GHz frequency range.

Additional information on external mixer measurements can be obtained from AN 150-12.

# Chapter 4

## TYPICAL MEASUREMENTS

### DISTORTION

Distortion measurement is an area where the spectrum analyzer makes a significant contribution. There are two basic types of distortion that are usually specified by the manufacturer: harmonic distortion and two-tone, third-order intermodulation distortion. The third-order intermodulation products are represented by:  $2f_1 - f_2$  and  $2f_2 - f_1$  where  $f_1$  and  $f_2$  are the two-tone input signals.

The HP 8565A can measure harmonic distortion products up to 100 dB down in the 1.7 to 22 GHz frequency range. Third-order intermodulation products can also be measured up to 100 dB down, depending on signal separation and frequency range. In all, the HP 8565A is capable

of making a wide variety of distortion measurements with speed and precision.

#### Amplifiers

All amplifiers generate some distortion at the output and these distortion products can be significant if the amplifier is overdriven with a high-level input signal. The test set-up in Figure 22 was used to measure the third-order intermodulation products of a microwave FET (Field-Effect Transistor) amplifier. Directional couplers and attenuators were used to provide isolation between sources.

Figure 23 is a CRT photo of a two-tone, third-order intermodulation measurement. The third-order products ( $2f_1 - f_2$  and  $2f_2 - f_1$ ) are 50 dB below the two-tone signals ( $f_1$  and  $f_2$ ).

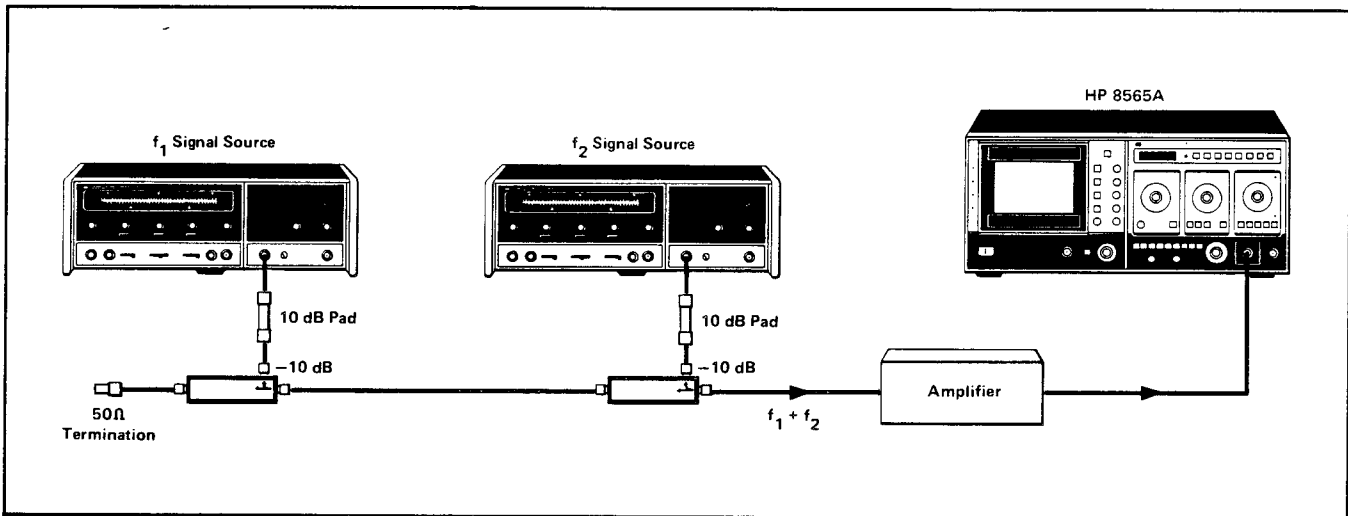

Figure 22. Two-tone test set-up

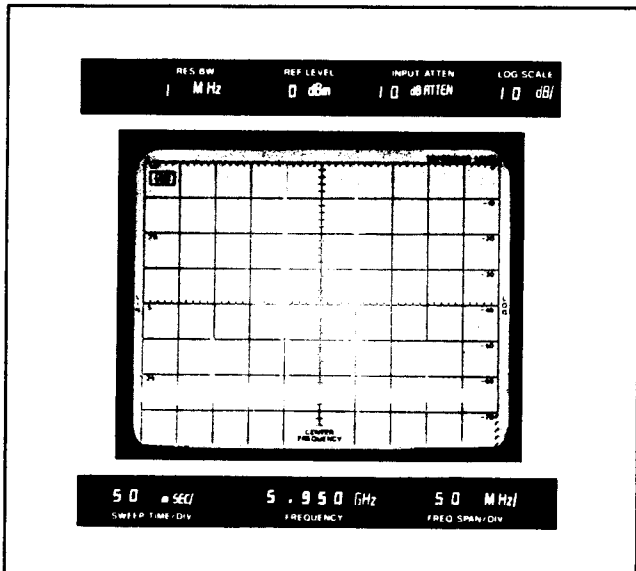

Figure 23. Two-tone, third-order intermodulation products

#### Mixers

Mixers utilize the non-linear characteristics of an active or passive device to achieve a desired frequency conversion. This results in some distortion at the output due to the inherent non-linearity of the device. Figure 24 illustrates the test set-up and CRT photograph of a typical mixer measurement.

From a single display, the following information was determined:

Conversion loss (SSB):

$$(RF_{in}) - (IF) = (-30) - (-40) = 10 \text{ dB}$$

LO to IF Isolation:

$$LO_{in} - LO_{out(IF)} = (+5) - (-25) = 30 \text{ dB}$$

RF to IF Isolation:

$$RF_{in} - RF_{out(IF)} = (-30) - (-57) = 27 \text{ dB}$$

Third-Order Distortion Product (2 LO - RF):

$$-64 \text{ dBm @ 600 MHz.}$$

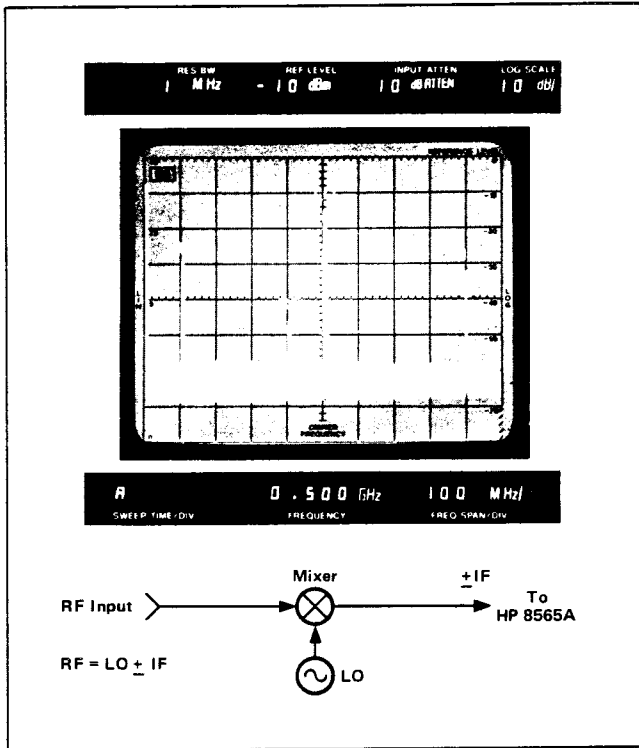

Figure 24. Mixer measurement

### Oscillators

Distortion in oscillators may be harmonically or non-harmonically related to the fundamental frequency. Non-harmonic oscillator outputs are usually termed spurious. Both harmonic and spurious outputs of an oscillator can be minimized with proper biasing and filtering techniques. The HP 8565A can monitor changes in distortion levels while modifications to the oscillator are made. In the full-band modes, a tuning marker can be located under any signal response to determine its frequency and hence its relationship to the oscillator's fundamental frequency. Figure 25 is a CRT photo of the fundamental and second harmonic of an S-Band (2 to 4 GHz) YIG oscillator. The

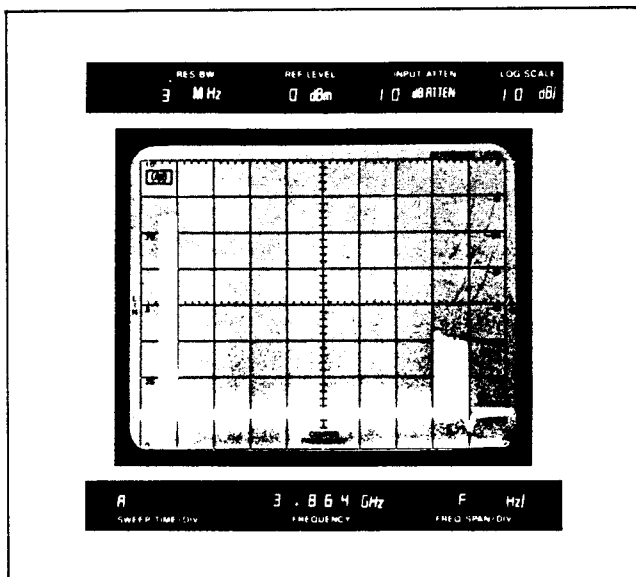

Figure 25. Oscillator fundamental and second harmonic

internal preselector of the HP 8565A enables the analyzer to measure a low-level harmonic in the presence of a high-level fundamental. The photo was obtained by adjusting the PERSIST control to allow storage of the trace and then tuning the oscillator over a narrow band.

Note: Consult AN 150-11 for more information on distortion measurements.

### MODULATION

#### AM

The wide dynamic range of the spectrum analyzer allows accurate measurement of modulation levels. A 0.06% modulation is a logarithmic ratio of 70 dB, which is easily measured with the HP 8565A. Figure 26 is a signal with 2% AM; a log ratio of 40 dB.

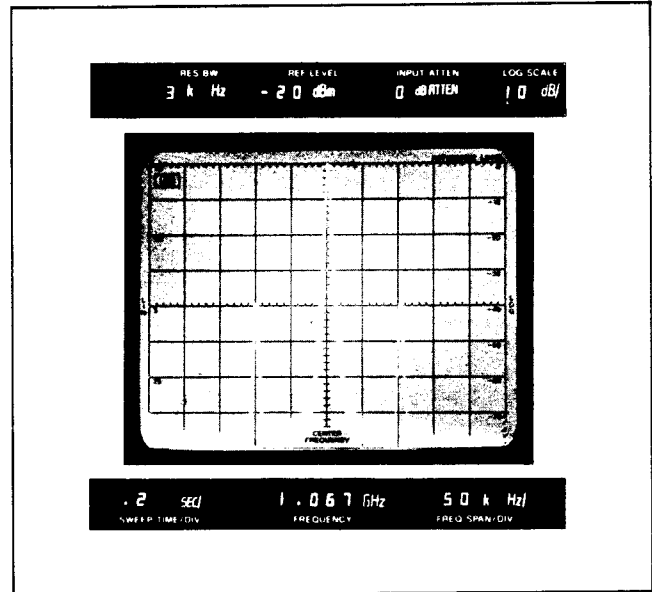

Figure 26. 2% AM

When the analyzer is used as a manually-tuned receiver (ZERO SPAN), the AM is demodulated and viewed in the time domain. To demodulate an AM signal, uncouple

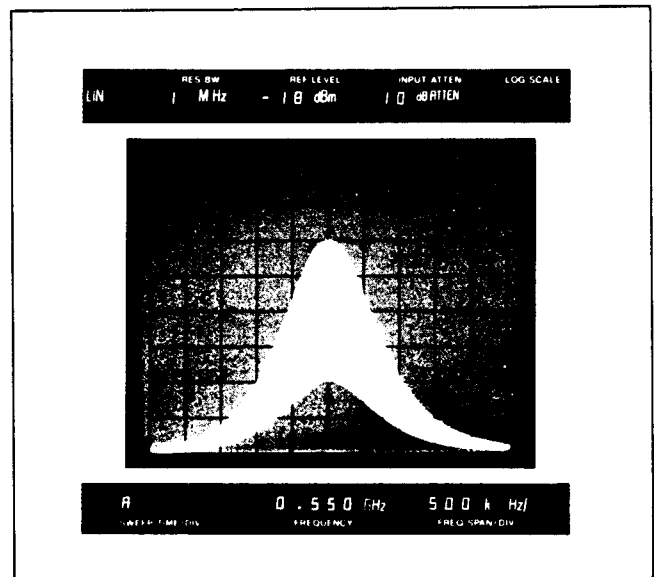

Figure 27. Linear amplitude display

the RESOLUTION BW and set it to a value at least twice the modulation frequency. Then set the AMPLITUDE SCALE to LIN and center the signal, horizontally and vertically, on the CRT. (See Figure 27)) By pushing ZERO SPAN and VIDEO triggering, the modulation will be displayed in the time domain. (See Figure 28.) The time variation of the modulation signal can then be measured with the calibrated SWEEP TIME/DIV control.

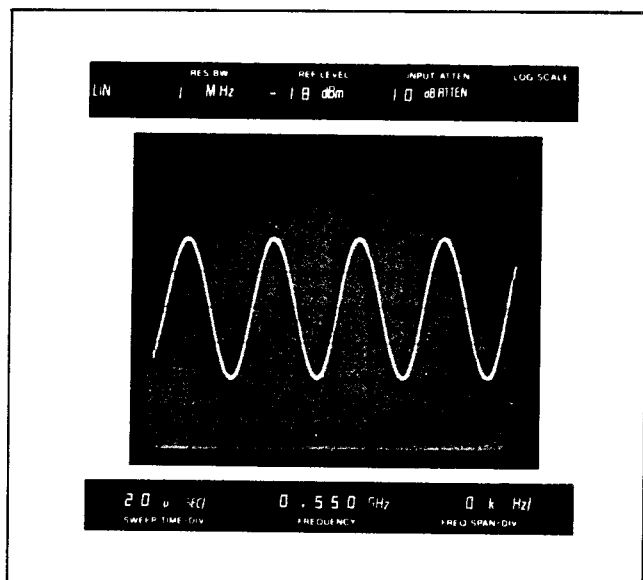

Figure 28. Demodulated AM signal in ZERO SPAN

### FM

For frequency modulated signals, parameters such as modulation frequency ( $f_m$ ), modulation index ( $m$ ), peak frequency deviation of carrier ( $\Delta f$  peak) are all easily measured with the HP 8565A. The FM signal in Figure 29 was adjusted for the carrier null which corresponds to  $m = 2.4$  on the *Bessel* function. The modulation frequency,  $f_m$ , is simply the frequency separation of the sidebands which is 50 kHz. From this, we can calculate the peak frequency deviation of the carrier ( $\Delta f$  peak) with the following equation:

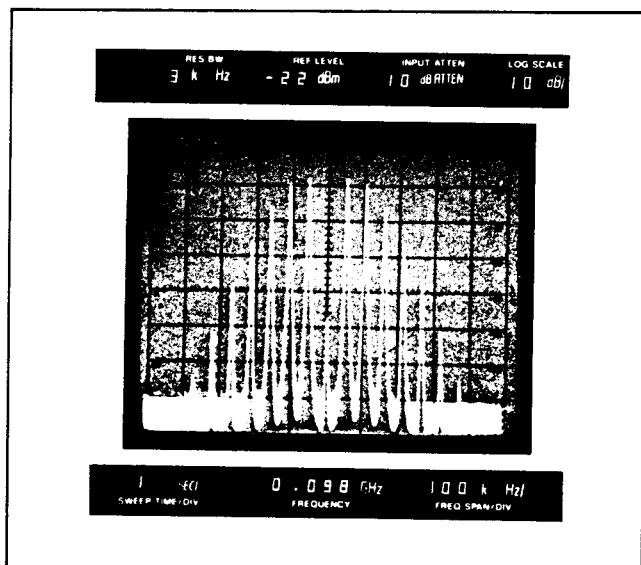

Figure 29. FM signal

$$m = \frac{\Delta f \text{ peak}}{f_m} \text{ or } \Delta f \text{ peak} = 2.4 \times 50 \text{ kHz} = 120 \text{ kHz.}$$

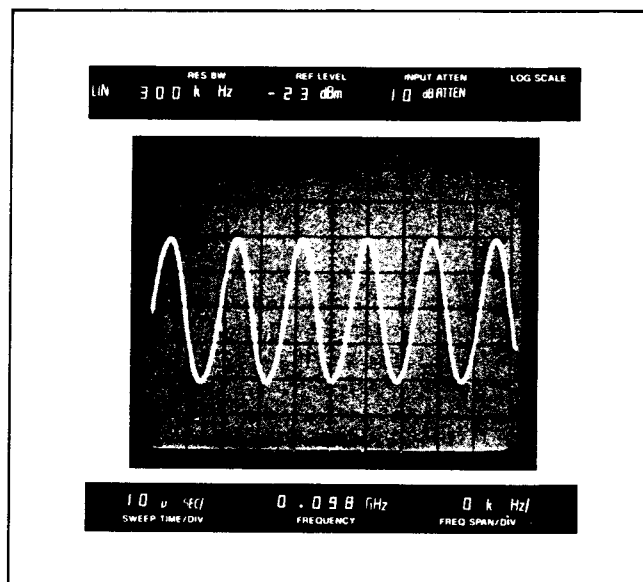

Figure 30. Demodulated FM signal in ZERO SPAN

Although the HP 8565A does not have a built-in discriminator, FM signals can be demodulated by slope detection. Rather than tuning the signal to the center of the CRT as in AM, the slope of the IF filter is tuned to the center of the CRT instead. At the slope of the IF filter, the frequency variation is converted to amplitude variation. When ZERO SPAN is selected, the amplitude variation is detected by the analyzer and displayed in the time domain as shown in Figure 30. In FM, the RESOLUTION BW must be increased to yield a display similar to Figure 31 before switching to ZERO SPAN.

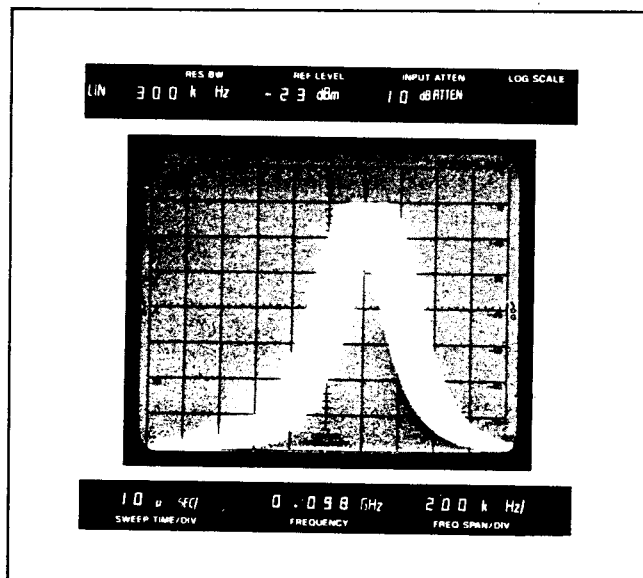

Figure 31. Slope detection of FM signal

Note: Consult AN 150-1 for more information on AM-FM.

### Pulsed RF

A pulsed RF signal is a train of RF pulses having constant amplitude. Some parameters to be determined in measuring pulsed RF signals are PRF (pulse repetition frequency), pulse width, duty cycle, peak and average pulse power, and the on-off ratio of the modulator. Figure 32 illustrates a *line* spectrum presentation of a pulsed RF signal.

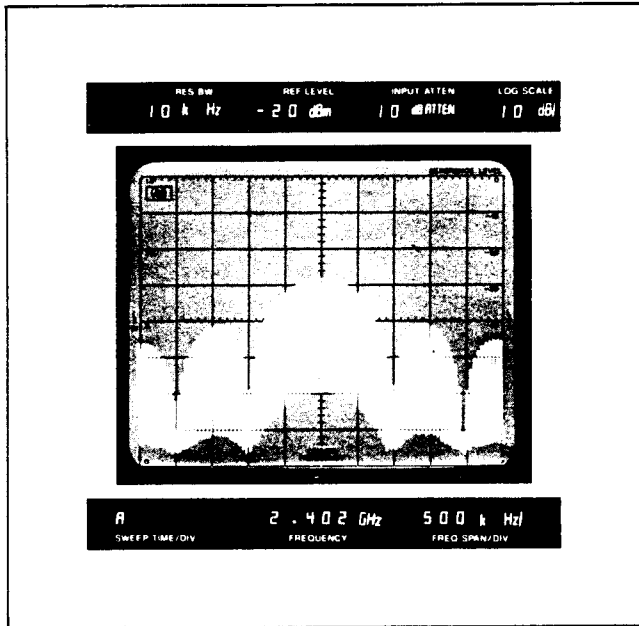

Figure 32. Line spectrum

A *line* spectrum (as opposed to a *pulsed* spectrum) is an actual Fourier representation of a pulsed RF signal; all the spectral components of the signal are fully resolved. To obtain a *line* spectrum on the analyzer, the “rule of thumb” to follow is that the RESOLUTION BW be less than  $0.3 \times \text{PRF}$ . This insures that individual spectral lines will be resolved. From the line spectrum shown in Figure 32, it is possible to measure the following parameters:

PRF = 50 kHz (spacing between spectral lines)

lobe width = 1 MHz

mainlobe power = -48 dBm

Then from the above measurement the following data can be calculated:

$$\text{Pulse width} = \frac{1}{\text{lobe width}} = \frac{1}{1 \text{ MHz}} = 1 \mu\text{s}$$

$$\text{Duty Cycle} = \frac{\text{PRF}}{\text{lobe width}} = \frac{50 \text{ kHz}}{1 \text{ MHz}} = 0.05$$

A factor to consider when measuring the amplitude of a pulsed RF signal is the pulse desensitization factor. The mainlobe power of a pulsed RF signal does not represent the actual peak power of the signal. This is because a pulsed signal has its power distributed over a number of spectral components and each component represents a fraction of the peak pulse power. The HP 8565A measures

the absolute power of each spectral component. To determine the peak pulse power in a line spectrum, a pulse desensitization factor ( $\alpha_L$ ) must be added to the measured mainlobe power. The desensitization factor is a function of the duty cycle and is represented by the following equation:

$$\alpha_L = 20 \log (\text{duty cycle})$$

For a duty cycle of 0.05,  $\alpha_L = -26 \text{ dB}$ . Hence the peak pulse power in Figure 33 is -22 dBm (-48 dBm +26 dB).

An alternate method of measuring a pulsed RF signal is in the *pulse* spectrum mode. In a *pulse* spectrum, the individual spectral lines are not resolved. If the RESOLUTION BW of the analyzer is greater than  $1.7 \times \text{PRF}$ , then the pulsed RF signal is being viewed in the *pulse* spectrum. Using the pulse spectrum enables a wider resolution bandwidth to be used. Two benefits result from this: first, the signal-noise ratio is increased because the pulse amplitude increases linearly with the resolution bandwidth (BW) whereas random noise increases only proportionally to the  $\sqrt{\text{BW}}$ . Hence the signal-noise ratio of the analyzer is effectively increased. Secondly, faster sweep times can be used because of the wider resolution bandwidths. The HP 8565A has a 3 MHz RESOLUTION BW which enables it to effectively display pulsed RF signals in the pulse spectrum. The 3 MHz bandwidth, along with fast sweep times, also enables narrow pulse widths to be measured in the time domain. Figure 33 illustrates a signal in the pulse spectrum. The same signal is demodulated with the analyzer in Figure 34.

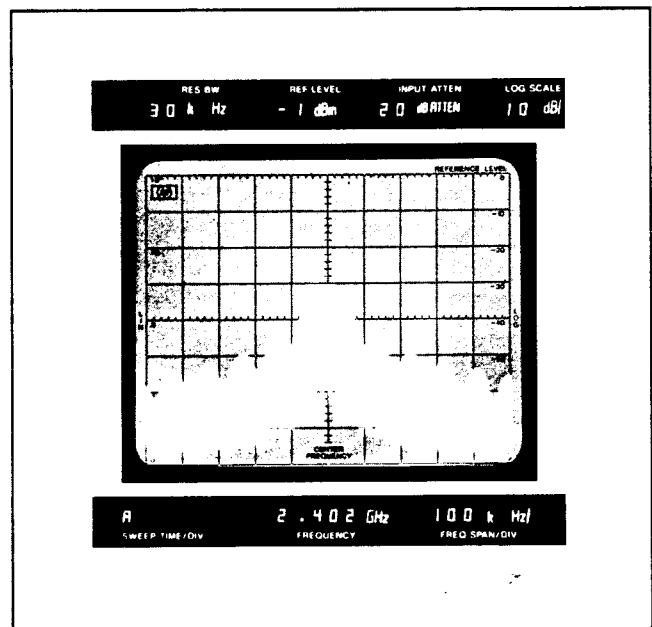

Figure 33. Pulse spectrum

An additional factor to consider when measuring pulsed RF signals is the VIDEO FILTER control. In general, the VIDEO FILTER should be left in the OFF position when measuring pulsed RF signals. Adding video filtering will desensitize a pulsed signal and limit its displayed amplitude. Hence, when monitoring pulsed signals in a full-band mode, it is important to use the F mode rather than

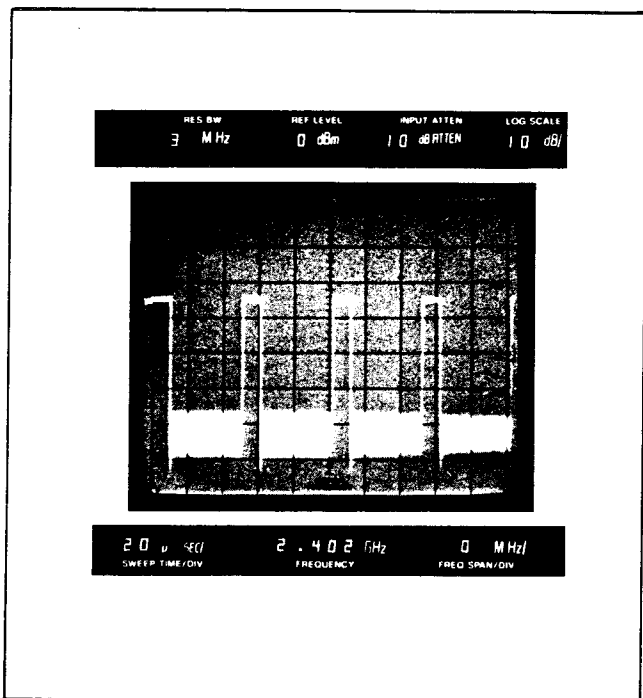

Figure 34. Demodulated pulsed RF signal in ZERO SPAN

the FULL BAND pushbutton mode. The FULL BAND mode automatically engages a 9 kHz VIDEO FILTER (0.003 x 3 MHz) which will limit the displayed amplitude of the pulse.

Note: Consult AN 150-2 for more information on pulsed RF.

## NOISE

Applications involving noise measurements include oscillator noise (spectral purity), signal-noise ratio, and noise figure. The NOISE AVG position of the VIDEO FILTER control can be used to measure the analyzer sensitivity or noise power from 0.01 to 22 GHz.

The test set-up in Figure 35 is used to make a swept noise figure measurement of an amplifier. In general, this measurement involves determining the total gain of the amplifier under test and the pre-amp. Then the input of the amplifier is terminated and its noise power is measured. The noise figure of the amplifier will then be the theoretical noise power (KTB) minus the total gain and the amplifier noise power. Figure 36 is a photo of an amplifier's noise power output from 0.01 to 1.3 GHz.

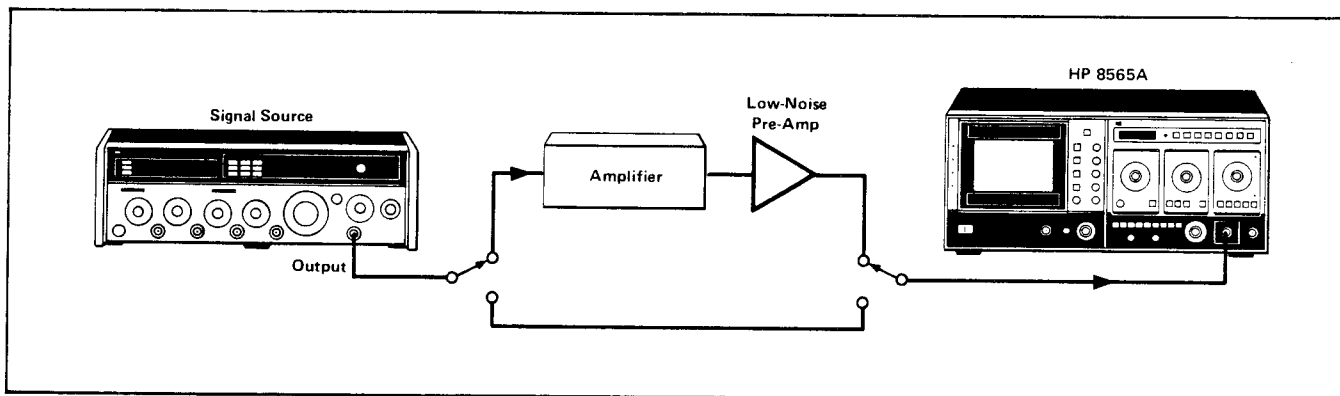

Figure 35. Swept noise figure test set-up

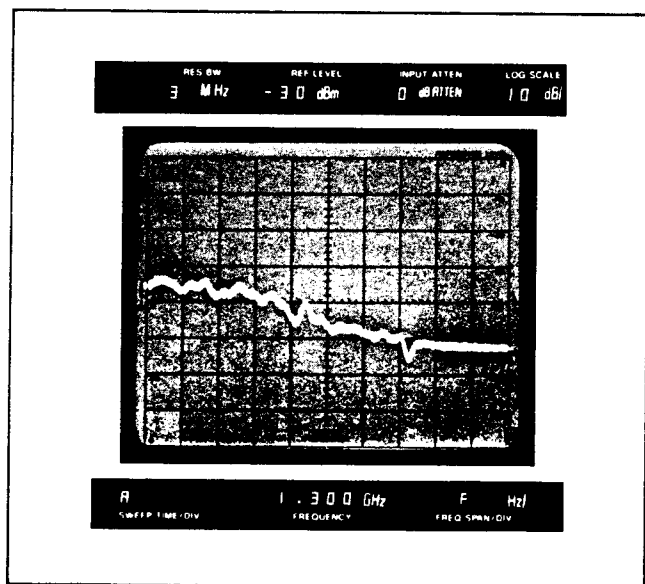

Figure 36. Noise power measurement

Note: Consult AN 150-4, AN 150-7 and AN 150-9 for more information on noise measurements.

## ELECTROMAGNETIC INTERFERENCE (EMI)

The overall objective of EMI measurements is to assure compatibility between devices operating in the same vicinity. The HP 8565A, along with an appropriate transducer, is capable of measuring either conducted or radiated EMI. Figure 37 illustrates a simple set-up used for measuring radiated field strength.

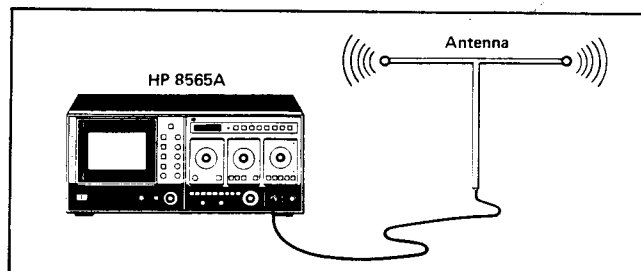

Figure 37. Field strength test set-up

The antenna is used to convert the radiated field to a voltage for the analyzer to measure. The field strength will be the analyzer reading plus the antenna correction factor. Figure 38 illustrates a typical signal generated by a DUT (Device Under Test) with spurious radiation.

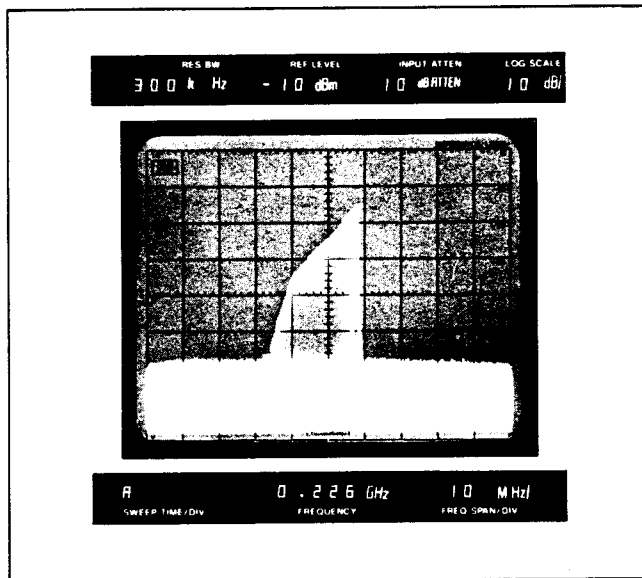

Figure 38. Spurious radiation

Compatibility is also important for high-frequency circuits which are in close proximity to each other. In a multi-stage circuit, parasitic oscillation from one stage can couple to a nearby stage and cause unpredictable behavior. A popular technique used to search for spurious

radiation is with an inductive loop probe. The loop probe is simply a few turns of wire that attaches to the spectrum analyzer with a flexible coaxial cable. (See Figure 39.)

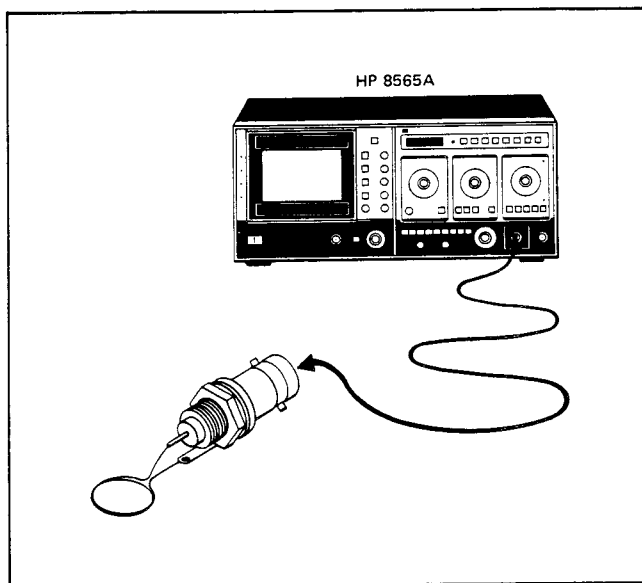

Figure 39. Loop probe

Various parts of the circuit can then be "probed" to identify the location as well as the frequency and relative amplitude of a spurious signal. Once the spurious signal has been identified, design techniques can be implemented to reduce or eliminate the cause of interference.

Note: Consult AN 150-10 and AN 63E for more information on EMI measurements.



# Appendix A

## OPERATING PRECAUTIONS

The spectrum analyzer is a sensitive measuring instrument. To avoid damage to the instrument, do not exceed the following **Absolute Maximum Inputs**:

- Total Power:** +30 dBm (1 watt)
- DC:** 0 V with 0 dB INPUT ATTEN  
±7 V with ≥10 dB INPUT ATTEN
- AC:** (<<50 Ω nominal source impedance):  
0 V with 0 dB INPUT ATTEN  
10 V peak with ≥10 dB INPUT ATTEN

Overloading the input with too much power, peak voltages or dc voltages will damage the input circuit and require expensive repairs.

### LOW IMPEDANCE AC

A source with less than 50 Ω nominal output impedance can produce excessive current which may damage the input circuit of the analyzer.

### DC PRECAUTIONS

The HP 8565A cannot accept DC voltages in 0 dB INPUT ATTEN. With 10 dB or greater INPUT ATTEN,

small DC voltages ( $\leq \pm 7$  V) can be accepted without damage if the total power (AC and DC) does not exceed 1 watt.

The input is direct-coupled and its DC input resistance varies from 0 to 87 Ω depending on the INPUT ATTEN and FREQUENCY BAND selected. (Refer to Figure 40.)

If large DC components are present with AC signals, a blocking capacitor should be used at the INPUT of the analyzer to eliminate the DC components.

Note: Input signal distortion may occur if DC voltages are applied in excess of those shown in the table below:

INPUT ATTEN	MAXIMUM DC Voltage (without distortion)
0 dB	0 V
10 dB	220 mV
20 dB	700 mV
30 dB	2.2 V
≥40 dB	7 V

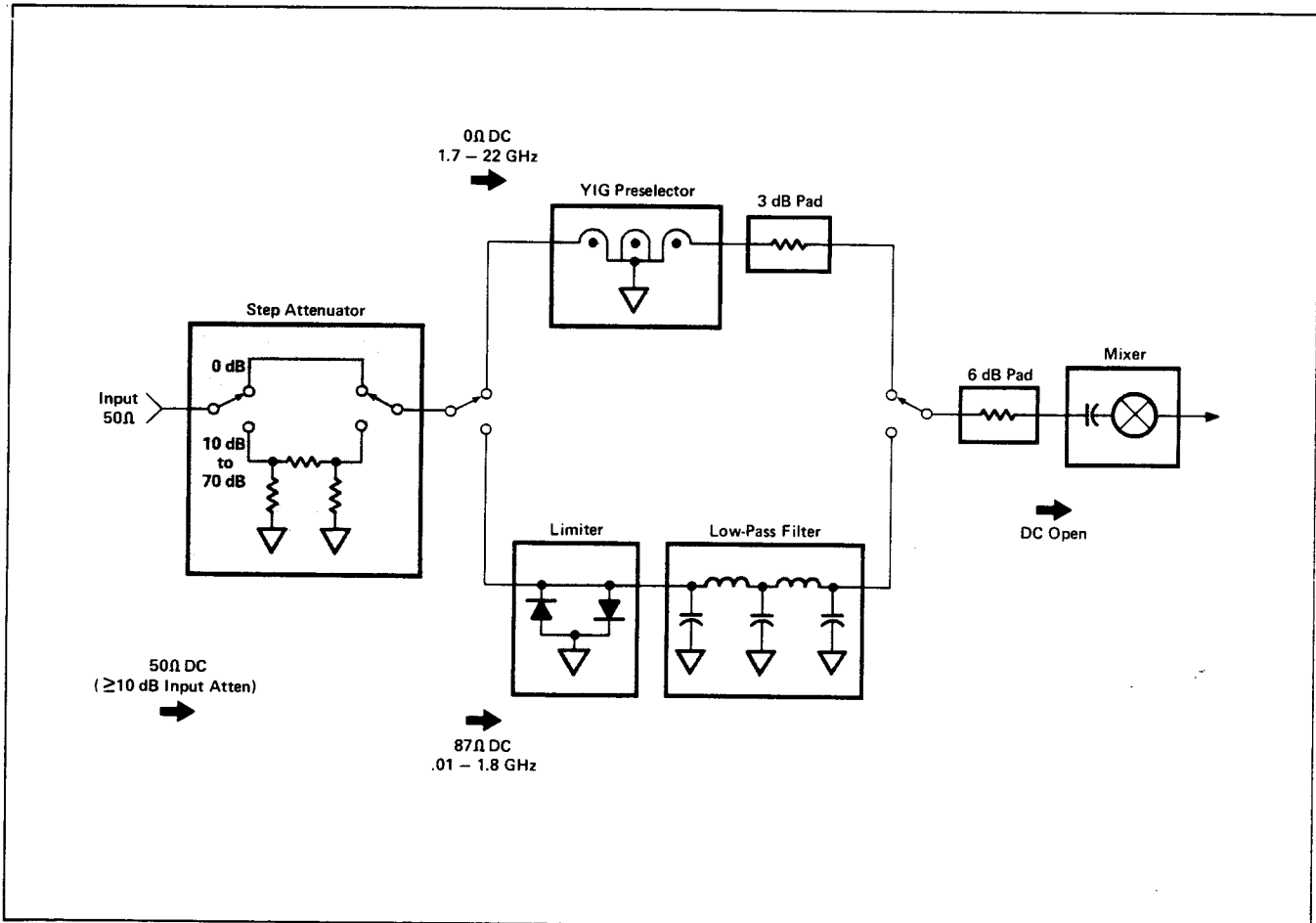

Figure 40. DC block diagram

# Appendix B

## CONTROL GLOSSARY

### FRONT PANEL

1. **LINE:** AC line switch. Turns instrument ON-OFF.
2. **ASTIG:** Used with FOCUS to obtain smallest spot size on CRT.
3. **TRACE ALIGN:** Rotates trace about center of CRT.
4. **HORIZ POSN:** Adjusts horizontal position of CRT trace.
5. **VERT POSN:** Adjusts vertical position of CRT trace.
6. **ERASE:** Removes trace from CRT. Operates in WRITE mode only.
7. **WRITE:** Allows CRT to write with variable persistence. Used for most applications.
8. **PERSIST:** Adjusts fade rate of trace in WRITE mode. Used to eliminate trace flickering.
9. **CONV:** Conventional (non-storage, short persistence) CRT display. Useful for observing fast sweeps in ZERO SPAN.
10. **INTENSITY:** Adjusts brightness of CRT trace.
11. **STORE:** Retains CRT trace at reduced intensity for photography or extended viewing. CRT does not write or erase in STORE mode. FREQUENCY readout is frozen.
12. **STORE INTEN:** Adjusts stored trace intensity for photography or viewing. Minimum intensity yields longest storage time.
13. **SCALE:** Sequentially erases trace, blanks CRT, and turns on scale illumination for photography. FREQUENCY readout is frozen.
14. **SCALE INTEN:** Adjusts scale illumination for photography.
15. **FOCUS:** Adjusts sharpness of CRT trace.
16. **BASELINE CLIPPER:** Adjusts the vertical level below which the CRT is blanked. Helps prevent blooming by blanking the bright baseline of area of CRT. Especially useful for pulsed RF and transient signals.
17. **CAL OUTPUT:** An internal 100 MHz, -10 dBm calibration signal.
18. **SIG IDENT:** Used to verify frequency of unknown signals. With FREQUENCY SPAN/DIV at 1 MHz, correct response will shift two divisions to the left and be lower in amplitude. Especially useful in EXT MIXER bands or when small signals present with large signals (ratio  $\geq 70$  dB). Note: SIG IDENT does not properly identify internal 100 MHz CAL OUTPUT signal.
19. **VIDEO FILTER:** Selects post-detection, low-pass filters which smooth the trace by averaging random noise. The VIDEO FILTER bandwidth is equal to the RESOLUTION BW times the factor indicated on the control knob. The NOISE AVG position is a fixed 1 Hz low-pass filter used for noise measurements only.
20. **FREQ CAL:** Calibrates the FREQUENCY readout to a known frequency reference.
21. **FREQUENCY:** Displays the tuned center frequency of analyzer in PER DIV and ZERO SPAN. In full-band modes, display reads frequency at the tuning marker.
22. **FREQUENCY BAND:** Selects frequency range.
23. **TUNING:** Tunes center frequency of analyzer or positions marker in full-band modes. Coarse tuning provided by large knob; push for *normal* and pull for *rapid*. Smaller knob provides FINE tuning.
24. **PRESELECTOR PEAK:** Adjusts tracking of internal YIG preselector. Normally centered in green area for best broadband performance from 1.7 to 22 GHz. Used to maximize signals for more accurate amplitude measurements.
25. **AUTO STABILIZER:** Analyzer is automatically stabilized for narrow frequency spans ( $\leq 100$  kHz/DIV). In stabilized mode, light is on and only FINE tuning should be used. Pushbutton switch (when depressed) disables AUTO STABILIZER to allow coarse tuning in narrow spans.
26. **FREQUENCY SPAN/DIV:** Selects CRT horizontal frequency calibration in PER DIV mode. Each major division on CRT (total of 10) represents frequency span selected.
27. **RESOLUTION BW:** Selects analyzer 3 dB IF bandwidth. Optimum resolution bandwidth for any frequency span automatically selected when markers are aligned ( $\blacktriangleright \blacktriangleleft$ ) and controls pushed in to couple. RESOLUTION BW can also be coupled at settings other than OPTIMUM or it can be operated independently (uncoupled).
28. **FREQUENCY SPAN MODE:** Selects desired span mode.
  - a. **ZERO SPAN:** Analyzer operates as a manually-tuned receiver to display detector output in time domain. The SWEEP TIME/DIV control is a calibrated time base when switched out of AUTO position.
  - b. **PER DIV:** Allows FREQUENCY SPAN/DIV control to select desired frequency span. With FREQUENCY SPAN/DIV control in F (full band), entire FREQUENCY BAND selected is displayed. A tuning marker, selectable RESOLUTION BW, and VIDEO FILTER are available in the F position.
  - c. **FULL BAND:** Spans the entire FREQUENCY BAND selected. A tuning marker is available and 3 MHz RESOLUTION BW and 0.003 VIDEO FILTER are automatically selected.
  - d. **1.7 - 22 GHz SPAN:** Analyzer spans 1.7 to 22 GHz in one sweep. A tuning marker is available and 3 MHz RESOLUTION BW and 0.003 VIDEO FILTER are automatically selected.
29. **REFERENCE LEVEL:** Controls power level (in dBm) represented by top graticule line of CRT. Adjustable in calibrated 10 dB steps with continuous calibrated 0 to -12 dB FINE vernier.
30. **INPUT ATTEN:** Push and turn to select desired RF input attenuation indicated by blue numbers. Yellow outlined numbers indicate MAXIMUM input level for  $< 1$  dB signal compression. A reminder light indicates ZERO dB input attenuation. ( $\geq 10$  dB INPUT ATTEN provides best input match).

31. **AMPLITUDE SCALE:** Selects log (dB/DIV) or linear vertical scale calibration. REFERENCE LEVEL remains constant at top graticule line.
32. **REF LEVEL CAL:** Calibrates REFERENCE LEVEL to a known amplitude reference.
33. **SWEEP SOURCE:** Selects desired sweep source.
  - a. **MAN:** Sweep controlled with MANUAL SWEEP knob.
  - b. **EXT:** Allows analyzer to be swept with external source.
  - c. **INT:** Analyzer sweeps repetitively with internal source. Synchronization selected by SWEEP TRIGGER.
34. **SWEEP TRIGGER:** Selects desired trigger source for INT sweep.
  - a. **FREE RUN:** Sweep triggered repetitively by internal source.
  - b. **LINE:** Sweep triggered by ac line frequency.
  - c. **VIDEO:** Sweep internally triggered by detected waveform of RF signal. Normally used for time domain analysis in ZERO SPAN.
  - d. **EXT:** Sweep triggered by external signal.
  - e. **SINGLE:** Sweep triggered by START/RESET pushbutton.
  - f. **START/RESET:** Dual function pushbutton; can start a single sweep or reset *any* internal sweep back to left edge of CRT.
  - g. **TRIGGER LEVEL:** Adjusts trigger level in VIDEO or EXT trigger mode. DC coupled, positive slope triggering. In VIDEO, + or - indicates trigger level relative to center horizontal graticule line.
  - h. **SWEEP:** Light is on while analyzer is sweeping.
35. **SWEEP TIME/DIV:** Selects time required to sweep one major horizontal division on CRT. AUTO position automatically selects proper sweep time as a function of FREQUENCY SPAN/DIV, RESOLUTION BW, and VIDEO FILTER settings to maintain a calibrated amplitude display. AUTO feature is retained when FREQUENCY SPAN/DIV and RESOLUTION BW are uncoupled. Control is calibrated time base when switched out of AUTO. Sweep times  $\leq 1$  msec/DIV are used for time domain analysis (ZERO SPAN) only.
36. **INPUT 50 $\Omega$ :** Type N female connector with 50 $\Omega$  input impedance. Used for signals from 0.01 to 22 GHz. CAUTION: Maximum input is +30 dBm (1 watt) and 0 volts DC. (See Operating Precautions.)
37. **EXT MIXER:** Input/output port for use with HP 11517A External Mixer. Used for measurements from 14.5 to 40 GHz in waveguide. The BNC connector supplies LO signal and DC bias to external mixer and receives IF signal from mixer. Terminate in 50 $\Omega$  load when not in use. CAUTION: Maximum input level to HP 11517A is 0 dBm (1 mW).
38. **EXT MIXER BIAS:** Controls amount of dc bias to HP 11517A mixer diode. Adjust to maximize signal amplitude.
39. **INFORMATION CARD:** Pull out to use. Card provides basic HP 8565A operating instructions and reference information.
40. **CRT BEZEL READOUT:** Displays all major spectrum analyzer settings.

## REAR PANEL

41. **HORIZONTAL SWEEP OUTPUT (X-axis):** A -5 V to +5 V output which is proportional to horizontal CRT deflection from left to right, respectively. 0.0 V corresponds to center of CRT. Output impedance is 5 k $\Omega$ . Used for driving horizontal channel of X-Y recorder or other external monitors.
42. **VERTICAL OUTPUT (Y-axis):** A 0 to +0.8 V detected video output which is proportional to vertical deflection on CRT. 0 V corresponds to bottom graticule line and +0.8 V corresponds to top graticule line. Output impedance is 50 $\Omega$ . Used for driving vertical channel of X-Y recorder or other external monitors. Also useful in ZERO SPAN for listening to detected output with headphones.
43. **BLANK OUTPUT (PENLIFT) (Z-axis):** A 0 or +15 V output which corresponds to CRT blanking during retrace and oversweeping of band edges. During unblank period (pen down) output is 0 V with 10 $\Omega$  output impedance. Caution: Maximum current sink 150 ma. During blank (pen up) output is +15 V with 10 k $\Omega$  output impedance. Used to control pen lift of X-Y recorder or blanking of other external monitor.
44. **EXT SWEEP INPUT:** With SWEEP SOURCE in EXT, a 0 to +10 V ramp will sweep analyzer across frequency span selected. Caution: Maximum input level is  $\pm 40$  V. Input impedance is 100 k $\Omega$ .
45. **EXT TRIGGER INPUT:** With SWEEP TRIGGER in EXT, a positive voltage  $>1$  V will trigger internal sweep source. TRIGGER LEVEL adjusts point (from 1 to 10 V) on trigger waveform which starts sweep. DC coupled, positive-slope triggering. Caution: Maximum input is  $\pm 40$  V. Input impedance is 100 k $\Omega$ .
46. **BLANKING INPUT:** Permits external blanking control of CRT. TTL compatible; high ( $>2$  V) blanks CRT, low ( $<0.5$  V) or an open circuit retains normal CRT operation. Caution: Maximum input is  $\pm 40$  V. Input impedance is 10 k $\Omega$ .
47. **1ST LO OUTPUT:** A 2.0 to 4.46 GHz, +8 dBm nominal output coupled from first local oscillator. Terminate with 50 $\Omega$  load when not in use. (See Appendix D for information on LO for each FREQUENCY BAND.)
48. **21.4 MHz IF OUTPUT:** A 21.4 MHz output linearly related to the RF input to analyzer. Bandwidth controlled by analyzer RESOLUTION BW setting. Amplitude controlled by INPUT ATTEN, REF LEVEL FINE and first six REFERENCE LEVEL step gain positions (0 to -50 dBm with 0 dB INPUT ATTEN). Output is approximately -10 dBm for full-scale signals on CRT. Output impedance is 50 $\Omega$ .
49. **AUX A:** Interconnection jack for interfacing HP 8750 Storage-Normalizer to analyzer.
50. **AUX B:** Interconnection jack for factory calibration of analyzer.
51. **POWER LINE MODULE:** Line voltage selector card allows choice of 100, 120, 220, or 240 volts (+5%, -10%). Line fuse contained in power line module. Warning: A 2 amp normal blow fuse must be used for 100 or 120 V operation and a 1 amp normal blow fuse must be used for 220 or 240 V operation.



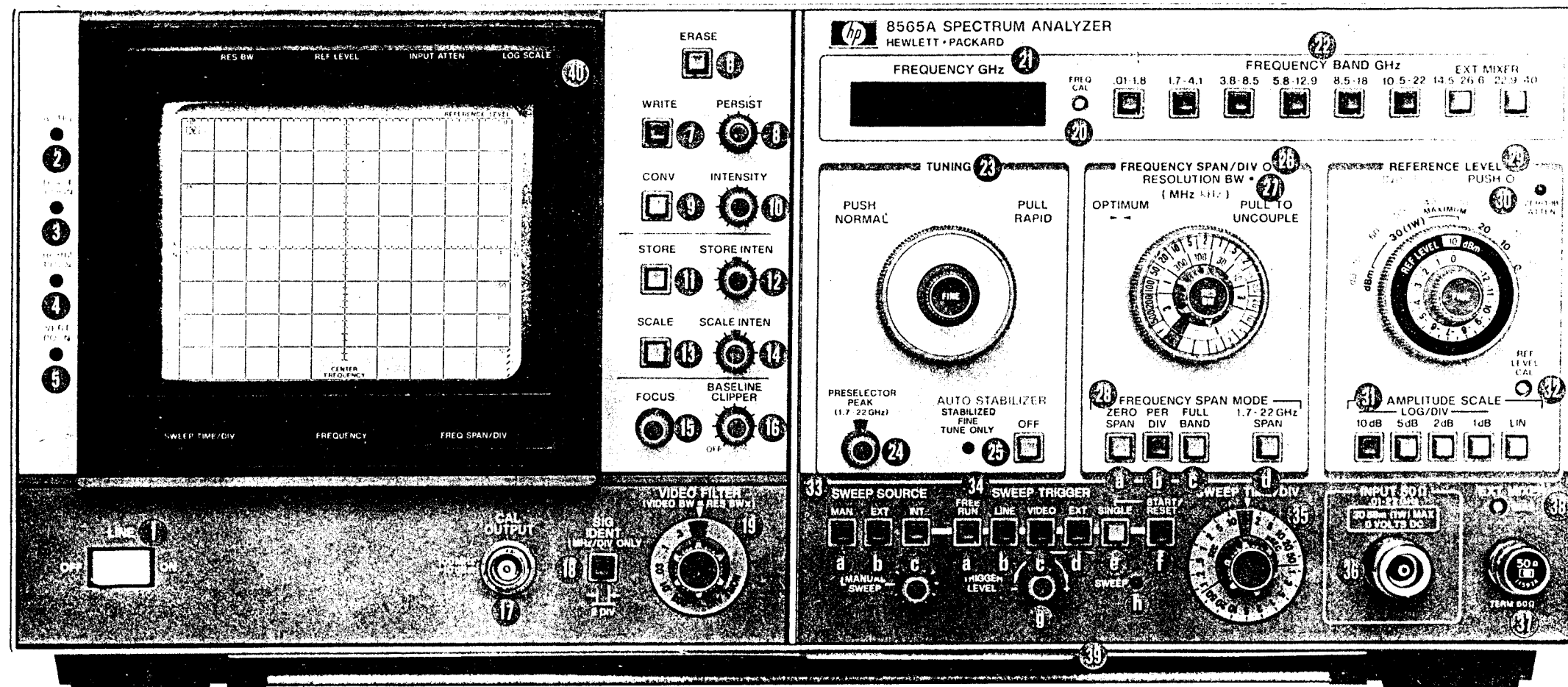

Figure 41. Front panel diagram

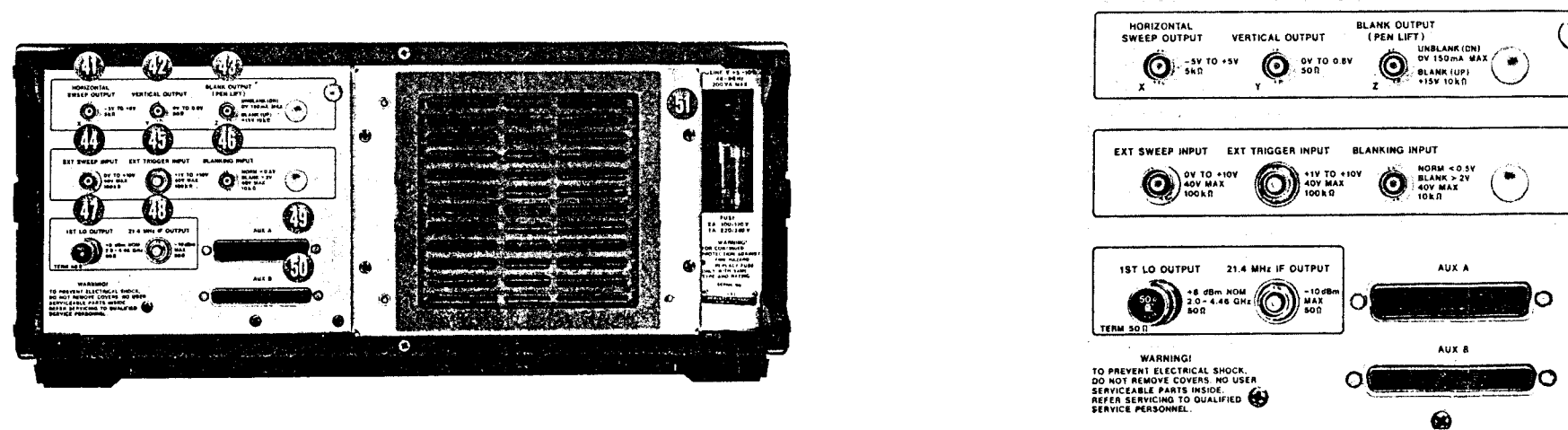

Figure 42. Rear panel diagram



# Appendix C

## FRONT PANEL ADJUSTMENT PROCEDURE

The Front Panel Adjustment optimizes the performance of the HP 8565A Spectrum Analyzer to obtain its specified accuracy. The following step-by-step procedure is recommended for adjusting the HP 8565A. A condensed procedure is also located on a pull-out INFORMATION CARD attached to the analyzer.

**Table 4. Normal settings**

Function	Setting
CRT DISPLAY	<input checked="" type="checkbox"/> WRITE
BASELINE CLIPPER	<input type="radio"/> OFF
FREQUENCY SPAN/DIV RESOLUTION BW	OPTIMUM (Push in) <input checked="" type="checkbox"/> (to couple)
FREQUENCY SPAN MODE	<input checked="" type="checkbox"/> PER DIV
AMPLITUDE SCALE	<input checked="" type="checkbox"/> 10 dB/DIV
VIDEO FILTER	<input type="checkbox"/> OFF
SWEEP SOURCE	<input checked="" type="checkbox"/> INT
SWEEP TRIGGER	<input checked="" type="checkbox"/> FREE RUN
SWEEP TIME/DIV	<input type="checkbox"/> AUTO
PRESELECTOR PEAK	<input type="checkbox"/> Center in green area

### PRE-ADJUSTMENT SETTINGS

1. Set Normal Settings on analyzer (Table 1).
2. Set FREQUENCY BAND to 0.01 - 1.8 GHz .
3. Set FREQUENCY SPAN/DIV to 0.2 MHz (200 kHz).
4. Set INPUT ATTEN to 10 dB.
5. Set REFERENCE LEVEL to -10 dBm and REF LEVEL FINE to 0 dB.
6. Set AMPLITUDE SCALE to LIN .

### DISPLAY ADJUSTMENTS

1. Adjust VERT POSN  to place the CRT trace on a horizontal graticule line near center of CRT.
2. Reduce INTENSITY and depress both INT  and EXT  SWEEP SOURCE to produce a dot on the CRT. Caution: Leaving a dot on the CRT for prolonged periods at high intensity may burn the phosphor.
3. Adjust ASTIG  and FOCUS for the smallest round dot.

4. Adjust HORIZ POSN  to center dot on the CRT. Reset to INT  SWEEP SOURCE.
5. Adjust TRACE ALIGN  so that the trace is parallel to a horizontal graticule line.
6. Adjust VERT POSN  to re-position baseline on the bottom graticule line.

### FREQUENCY ADJUSTMENT

Connect 100 MHz CAL OUTPUT signal to INPUT and center signal on CRT with TUNING control. Adjust FREQ CAL  to indicate 0.100 GHz on FREQUENCY read-out.

### AMPLITUDE ADJUSTMENT

Set AMPLITUDE SCALE to 1 dB/DIV .

Adjust REF LEVEL CAL  to position the peak of the signal on the REFERENCE LEVEL (top graticule line) of the CRT.

Once the Front Panel Adjustment Procedure is completed, the CRT display should look similar to Figure 43.

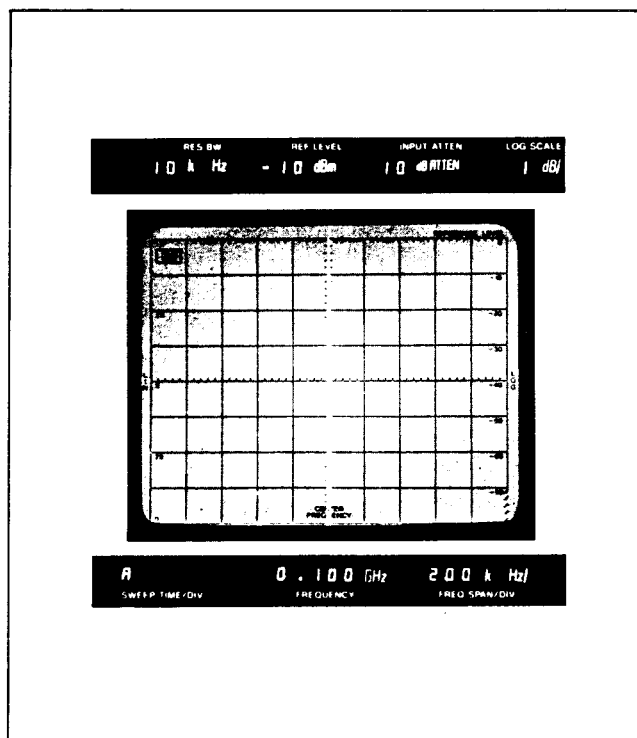

**Figure 43. CAL OUTPUT signal**

Reset the AMPLITUDE SCALE to 10 dB/DIV . The HP 8565A is now calibrated for absolute frequency and amplitude measurement.

# Appendix D

## THEORY OF OPERATION

### SYSTEMS DESCRIPTION

The HP 8565A Spectrum Analyzer is basically an electronically-swept superheterodyne receiver. It has high sensitivity and selectivity, a wide distortion-free dynamic range, and excellent flatness from 10 MHz to 22 GHz. With external mixing, frequency coverage can be extended up to 40 GHz. The HP 8565A consists of an RF and IF section, an automatic stabilization and control section, and a display section. Each of these sections will be discussed separately in this appendix. A simplified block diagram (Figure 44) is shown below for reference.

### RF SECTION

The RF section is composed of a 0-70 dB step attenuator, an automatic preselector, a tunable local oscillator (LO), and a broadband mixer. The step attenuator at the input to the spectrum analyzer is used to control the signal level to the mixer for optimum dynamic range and signal-noise ratio. The automatic preselector consists of a low-pass filter from 0.01 to 1.8 GHz and a YIG-tuned filter (YTF) from a 1.7 to 22 GHz. Coaxial switches are used to switch to the proper filter depending on frequency band chosen. The automatic preselector eliminates most image, multiple, and spurious responses of the analyzer and thus enhances its dynamic range. A transistorized YIG-tuned oscillator (YTO) with a fundamental tuning range of 2.05 to 4.46 GHz is used as the LO in this superheterodyne system.

The basic frequency conversion equation for a heterodyne system is given by equation 1:

$$(1): \quad f_s = f_{i_0} \pm f_{i_f}$$

where:  $f_s$  = signal frequency

$f_{i_0}$  = local oscillator frequency

$f_{i_f}$  = intermediate frequency

The first IF in the HP 8565A is set at 321.4 MHz and the first LO sweeps from 2.0 to 4.46 GHz. Therefore, from equation 1,  $f_s$  would cover approximately 1.68 to 4.14 GHz in fundamental operation. With harmonic mixing, given by equation 2:

$$(2): \quad f_s = n f_{i_0} \pm f_{i_f}$$

where:

$n$  (harmonic number) = 1-, 2-, 3-, 4+, 5+, 6+, 10+

the frequency range is extended to 40 GHz. Each harmonic number creates a tuning curve which is illustrated in Figure 45, page 28. Signal frequencies from 0.01 to 1.8 and 1.7 to 22 GHz are converted to a 2050 MHz and 321.4 MHz IF respectively with the broadband internal mixer. In the 1.7 to 22 GHz frequency range, the YIG-tuned filter tracks a particular tuning curve and thus eliminates spurious responses resulting from harmonic mixing. From 14.5 to 40 GHz, an external waveguide mixer is used to convert the input signals to a 2050 MHz IF which is then further processed by the analyzer.

### AUTOMATIC STABILIZATION SECTION

Many factors can limit the resolution of the spectrum analyzer. Among these are the local oscillator's stability and spectral purity, and the IF filter's bandwidth and shape factor. Of these limitations, the most significant one for microwave analyzers is usually the stability (residual FM or drift) of an oscillator. For this reason, the HP

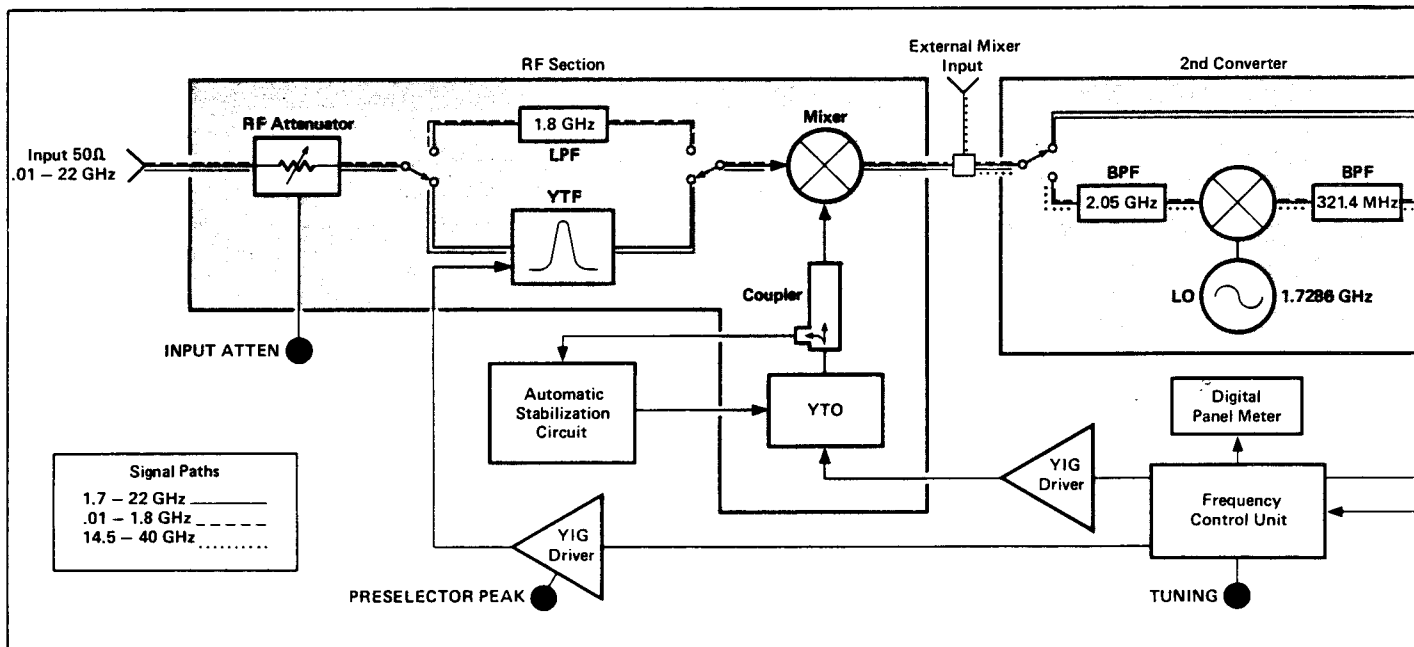

Figure 44. HP 8565A block dia



8565A utilizes an automatic stabilization circuit that locks the YTO to a 1 MHz crystal reference oscillator. The lock is automatically engaged when frequency spans of 100 kHz/DIV or less are selected. The AUTO STABILIZER can be disabled by a pushbutton switch located on the front panel. An added feature to the automatic stabilization circuit is the use of offset compensation to maintain the signal of interest fixed on the CRT during stabilization. The circuit is designed such that the YTO is not moved when it is locked to the reference oscillator. Since there is no frequency shift in the YTO, the displayed signal will not shift either. This eliminates the need for the user to retune the signal on the CRT once it has been stabilized.

## IF SECTION

The IF section consists of components in the signal path after the first mixer. The output from the first mixer is either 321.4 MHz or 2050 MHz. Signals at 321.4 MHz bypass the second converter whereas a 2050 MHz signal would mix with the second LO at 1.7286 GHz to also produce a 321.4 MHz IF. At the third converter, the 321.4 MHz IF is amplified, filtered, and mixed with the third LO at 300 MHz to produce a final IF of 21.4 MHz. The output of the third converter goes to a variable gain amplifier, selectable bandpass filters, variable gain logarithmic, and linear amplifiers, and is then detected. The detected video signal goes through a selectable video filter and a vertical amplifier to be processed for the display. The IF bandpass filter, log and linear amplifiers, and video filter are all controllable from the front panel of the spectrum analyzer.

## DISPLAY SECTION

The sweep voltage that is used to tune the YTO is simultaneously applied to the horizontal deflection amplifiers in the CRT. The video output of the IF section is

then synchronously applied to the vertical deflection amplifier and a plot of frequency vs. amplitude results on the CRT.

LED's are embedded in the CRT bezel to allow easy readout of control settings and also to extend the usefulness of CRT photography. The CRT bezel readout displays all pertinent information related to the amplitude, frequency, and sweep time of the analyzer.

Because some combinations of resolution bandwidth, frequency span, and video filtering require slow sweep times, a variable persistence CRT is used to provide a flicker-free display of the signal. The CRT also has storage capability which is useful for extended viewing or photography.

## TUNING CONTROL SECTION

The tuning control section contains the Frequency Control Board, YIG driver, Digital Panel Meter (DPM), sweep attenuator, and sweep generator.

The sweep generator provides a sweep voltage that is simultaneously applied to the horizontal deflection amplifier and the sweep attenuator. The sweep attenuator, controlled by the FREQUENCY SPAN/DIV control, reduces the sweep voltage to the Frequency Control Board to maintain a calibrated horizontal scale on the CRT. In addition, the tuning control voltage, which sets the center frequency of the analyzer, is also applied to the Frequency Control Board. The tuning control voltage and the sweep attenuator voltage are summed and scaled in the Frequency Control Board. The resultant signal is then applied to the YIG drivers. Both the YTF and the YTO have separate YIG drivers which are basically voltage-to-current converters. A preselector peak adjustment is used to control the offset of the YTF's YIG driver circuit. It is adjusted to eliminate any amplitude uncertainty due to mis-tracking between the YTF and the YTO. A DPM readout displays the frequency represented by the center of the CRT display.

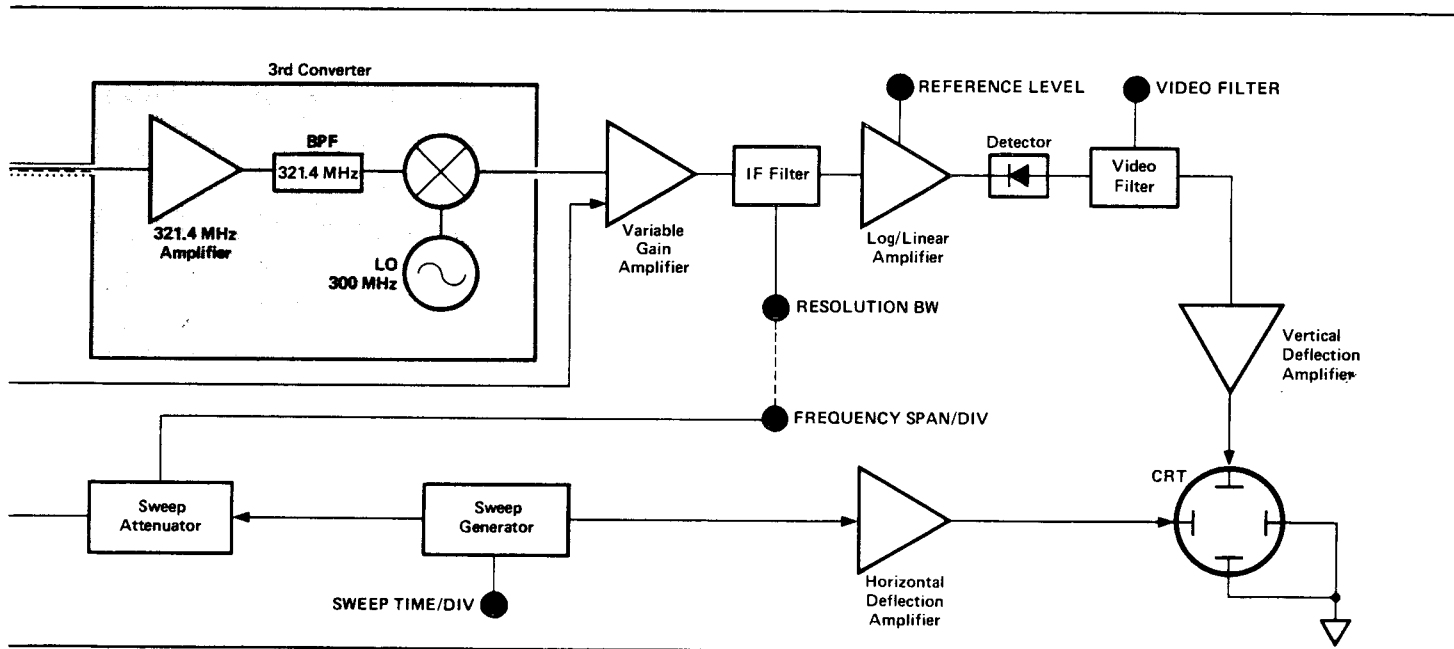

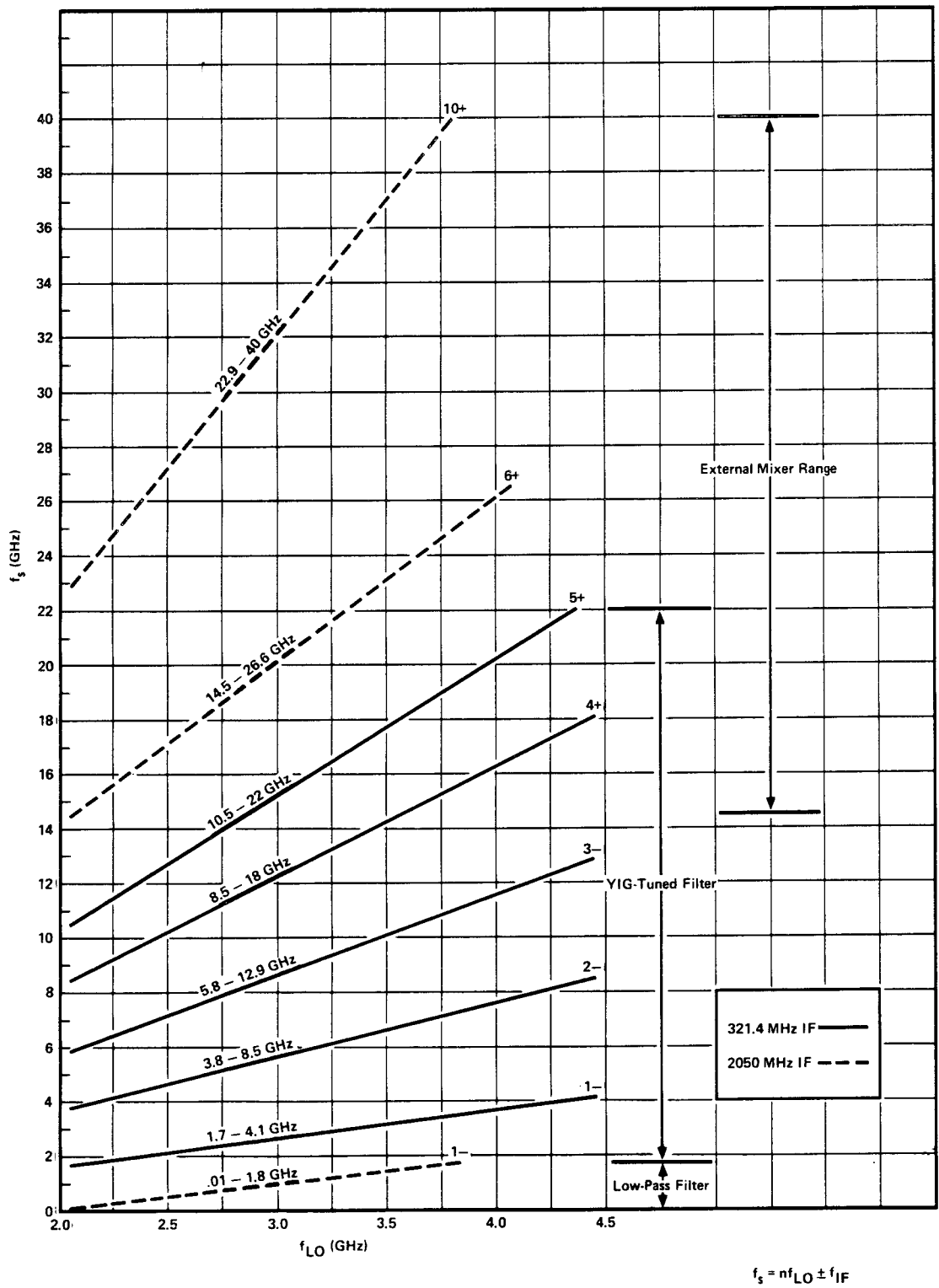

Figure 45. HP 8565A tuning curves

# Appendix E

## AMPLITUDE CONVERSIONS

The HP 8565A Spectrum Analyzer reads signal levels in dBm. The following equations allow conversion from dBm to dBmV or dB $\mu$ V in a 50  $\Omega$  system.

### CONVERSION EQUATIONS

$$\begin{aligned} \text{dBm} + 107 \text{ dB} &= \text{dB}\mu\text{V} \\ \text{dBm} + 47 \text{ dB} &= \text{dBmV} \\ \text{dBmV} + 60 \text{ dB} &= \text{dB}\mu\text{V} \end{aligned}$$

If it is desired to convert from logarithmic units to linear units, then the equations given below will be useful. Keep in mind that the logarithmic levels are all referenced to linear units.

- i.e., 0 dBm referenced to 1 mW
- 0 dBmV referenced to 1 mV
- 0 dB $\mu$ V referenced to 1  $\mu$ V

Therefore, to calculate a linear level, simply take the antilog of the logarithmic level.

$$\text{dBm to } P(\text{mW})$$

$$\text{dBm} = 10 \log \frac{P}{1 \text{ mW}}, P = \log^{-1} \frac{\text{dBm}}{10}$$

$$\text{dBmV to } V(\text{mV})$$

$$\text{dBmV} = 20 \log \frac{V}{1 \text{ mV}}, V = \log^{-1} \frac{\text{dBmV}}{20}$$

$$\text{dB}\mu\text{V to } V(\mu\text{V})$$

$$\text{dB}\mu\text{V} = 20 \log \frac{V}{1 \mu\text{V}}, V = \log^{-1} \frac{\text{dB}\mu\text{V}}{20}$$

Figure 46 below converts from dBm to voltage in a 50  $\Omega$  system.

Conversion from dBm to volts can be made whether the AMPLITUDE SCALE is in LOG/DIV or LINEar. To read voltage on the HP 8565A, position the signal on the REFERENCE LEVEL line of the CRT. Read the REF LEVEL in dBm and find its equivalent voltage from the Conversion Chart.

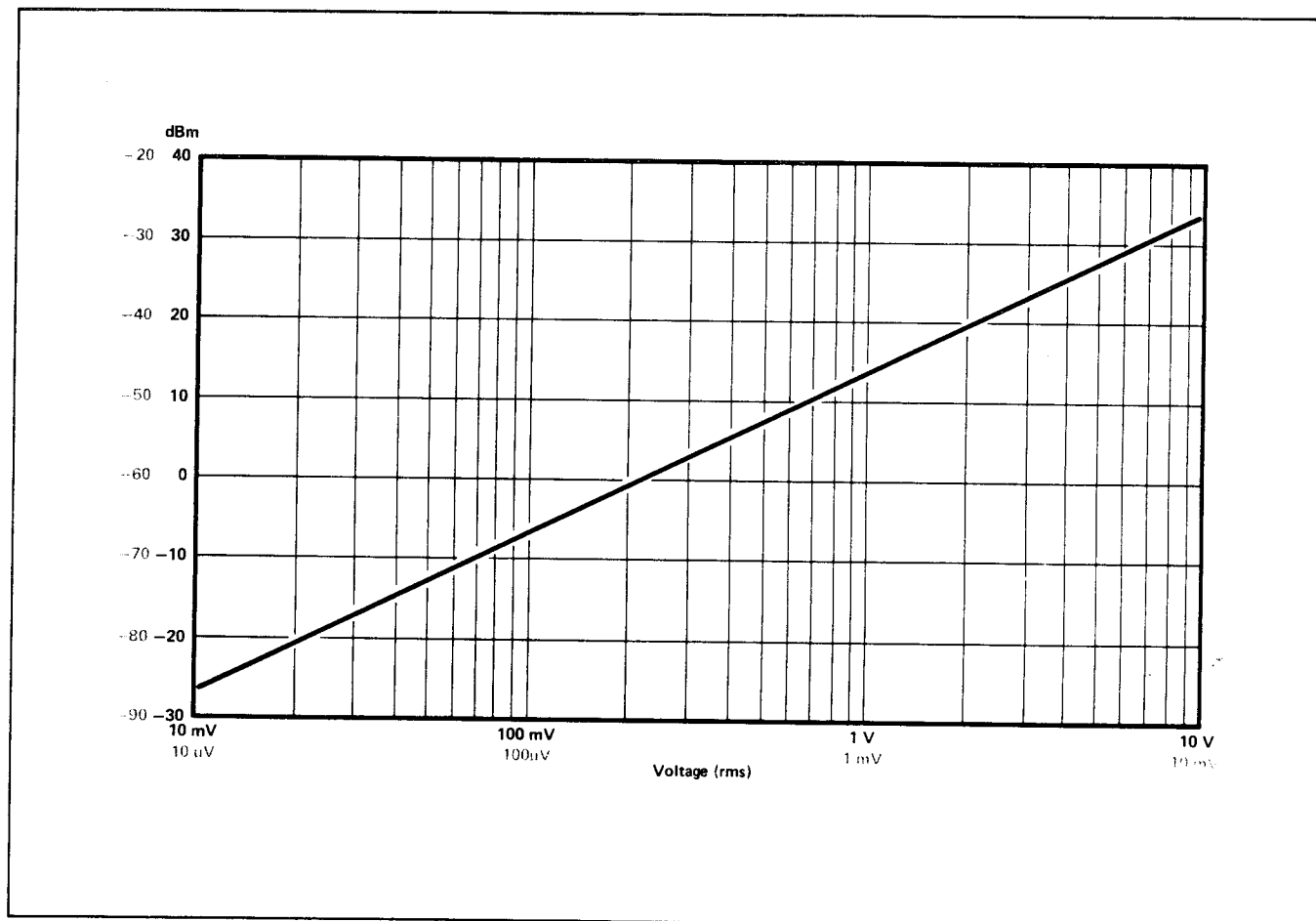

Figure 46. Conversion chart—converts from dBm to voltage in 50  $\Omega$

